

Aficio™

AP400/AP400N

Setup Guide

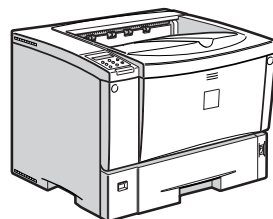

-
- 1 Getting Started
 - 2 Installing Options
 - 3 Configuring the Printer for the Network
 - 4 Installing the Printer Driver and Software

Introduction

This manual describes detailed instructions on the operation and notes about the use of this machine. To get maximum versatility from this machine all operators are requested to read this manual carefully and follow the instructions. Please keep this manual in a handy place near the machine.

Power Source

220 - 240 V, 50/60 Hz, 4.1 A or more

Please be sure to connect the power cord to a power source as shown above.

Two kinds of size notation are employed in this manual. With this machine refer to the metric version.

Operator Safety:

This printer is considered a class 1 laser device, safe for office/ EDP use. The printer contains 5-milliwatt, 760 - 800 nanometer wavelength, GaAlAs laser diode. Direct (or indirect reflected) eye contact with the laser beam might cause serious eye damage. Safety precautions and interlock mechanisms have been designed to prevent any possible laser beam exposure to the operator.

The following label is attached on the back of the printer.



Laser Safety:

The optical housing unit can only be repaired in a factory or at a location with the requisite equipment. The laser subsystem is replaceable in the field by a qualified Customer Engineer. The laser chassis is not repairable in the field. Customer engineers are therefore directed to return all chassis and laser subsystems to the factory or service depot when replacement of the optical subsystem is required.

Important

Contents of this manual are subject to change without prior notice. In no event will the company be liable for direct, indirect, special, incidental, or consequential damages as a result of handling or operating the machine.

Caution:

Use of controls or adjustment or performance of procedures other than those specified in this manual might result in hazardous radiation exposure.

Do not attempt any maintenance or troubleshooting other than that mentioned in this manual. This printer contains a laser beam generator and direct exposure to laser beams can cause permanent eye damage.

For good copy quality, supplier recommends that you use genuine supplier's toner.

The supplier shall not be responsible for any damage or expense that might result from the use of parts other than genuine supplier's office product.

TABLE OF CONTENTS

Trademarks	1
Safety Information	2
Safety During Operation.....	2
ENERGY STAR Program	5
Manuals for This Printer	6
Manuals for This Printer.....	6
How to Read This Manual	7

1. Getting Started

Printer Drivers for This Printer	9
Software and Utilities Included on the CD-ROM	11
Viewing the Contents of the CD-ROM	12
Guide to This Printer	13
Mainframe	13
Control Panel	16

2. Installing Options

Available Options	20
Paper Feed Unit Type 400	23
Envelope Feeder Type 400	25
Memory Unit Type C (SDRAM Module)	26
Network Interface Board Type 2610	29
Installing the Network Interface Board	29
Connecting the Network Interface Cable to the Network	31
1394 Interface Unit Type 4510	33
Installing the 1394 Interface Unit.....	33
Connecting the 1394 Interface Cable to the Printer	36
802.11b Interface Unit Type A	37
Bluetooth Interface Unit Type 2045	40
Hard Disk Drive Type 2600	44
AD450 (Duplex Unit)	46

3. Configuring the Printer for the Network

Ethernet Configuration	49
IEEE 1394 Configuration	54
IEEE 802.11b (Wireless LAN) Configuration	57

4. Installing the Printer Driver and Software

Installation Method	59
Quick Install	60
Installing the PCL 6/5e Printer Driver	62
Installing the PCL 6/5e Printer Driver.....	62
Setting Up Options	63
Installing the RPCS Printer Driver	65
Installing the RPCS Printer Driver.....	65
Setting Up Options	66
Installing the PostScript Printer Driver	68
Windows 95/98/Me - Installing the PostScript Printer Driver.....	68
Windows 2000/Windows XP/Server 2003 - Installing the PostScript Printer Driver ...	70
Windows NT 4.0 - Installing the PostScript Printer Driver.....	72
Mac OS - Installing the PostScript 3 Printer Driver	75
Mac OS X - Installing the PostScript 3 Printer Driver	78
Installing the Printer Driver Using USB	80
Windows 98SE/Me-Installing the Printer Driver Using USB.....	80
Windows 2000/Windows XP/Server 2003-Installing the Printer Driver Using USB...	81
Mac OS-Creating a Desktop Printer icon	81
Installing the Printer Driver Using IEEE 1394	83
Printing with SCSI Print.....	83
Printing with IP over 1394	86
Installing the SmartNetMonitor for Client/Admin	88
Installing the Font Manager 2000	89
Using Adobe PageMaker Version 6.0, 6.5, or 7.0	90
INDEX	91

Trademarks

Microsoft, Windows and Windows NT are registered trademarks of Microsoft Corporation in the United States and/or other countries.

Novell, Netware, NDS are registered trademarks of Novell, Inc.

PostScript is a registered trademark of Adobe Systems, Incorporated.

PCL is a registered trademark of Hewlett-Packard Company.

AppleTalk, Apple, Macintosh, TrueType and LaserWriter are registered trademarks of Apple Computer, Incorporated.

IPS-PRINT Printer Language Emulation Copyright© 1999-2000 Oak Technology, Inc., All rights reserved.

Ethernet is a registered trademark of Xerox Corporation.

Bluetooth is a Trademark of the Bluetooth SIG, Inc. (Special Interest Group) and licensed to RICOH Company Limited.

Other product names used herein are for identification purposes only and might be trademarks of their respective companies. We disclaim any and all rights in those marks.

- The product name of Windows® 95 is Microsoft® Windows® 95.
- The product name of Windows® 98 is Microsoft® Windows® 98.
- The product name of Windows® Me is Microsoft® Windows® Millennium Edition (Windows Me).
- The product names of Windows® 2000 are as follows:
 - Microsoft® Windows® 2000 Advanced Server
 - Microsoft® Windows® 2000 Server
 - Microsoft® Windows® 2000 Professional
- The product names of Windows® XP are as follows:
 - Microsoft® Windows® XP Professional
 - Microsoft® Windows® XP Home Edition
- The product names of Windows Server™ 2003 are as follows:
 - Microsoft® Windows Server™ 2003 Standard Edition
 - Microsoft® Windows Server™ 2003 Enterprise Edition
 - Microsoft® Windows Server™ 2003 Web Edition
- The product names of Windows NT® 4.0 are as follows:
 - Microsoft® Windows NT® Server 4.0
 - Microsoft® Windows NT® Workstation 4.0

Notes:

Some illustrations in this manual might be slightly different from the machine. Certain options might not be available in some countries. For details, please contact your local dealer.

Safety Information

When using your printer, the following safety precautions should always be followed.

Safety During Operation

In this manual, the following important symbols are used:

- | |
|----------------------------------------------------------------------------------------------------------------------------------------------------------------------------------------------------------------------------------------------------------------------------------------------------------------------------------------------------------|
| <p>⚠ WARNING:
<i>Indicates a potentially hazardous situation which, if instructions are not followed, could result in death or serious injury.</i></p> <p>⚠ CAUTION:
<i>Indicates a potentially hazardous situation which, if instructions are not followed, may result in minor or moderate injury or damage to property.</i></p> |
|----------------------------------------------------------------------------------------------------------------------------------------------------------------------------------------------------------------------------------------------------------------------------------------------------------------------------------------------------------|

⚠ WARNING:

- | |
|------------------------------------------------------------------------------------------------------------------------------------------------------------------------------------------------------------------------------------------------------------------------------------------------------------------------------------------------------------------------------------------------------------------------------------------------------------------------------------------------------------------------------------------------------------------------------------------------------------------------------------------------------------------------------------------------------------------------------------------------------------------------------------------------------------------------------------------------------------------------------------------------------------------------------------------------------------------------------------------------------------------------------------------------------------------------------------------------------------------------------------------|
| <ul style="list-style-type: none">• Connect the power cord directly into a wall outlet and never use an extension cord.• Disconnect the power plug (by pulling the plug, not the cable) if the power cable or plug becomes frayed or otherwise damaged.• To avoid hazardous electric shock or laser radiation exposure, do not remove any covers or screws other than those specified in this manual.• Turn off the power and disconnect the power plug (by pulling the plug, not the cable) if any of the following occurs:<ul style="list-style-type: none">• You spill something into the machine.• You suspect that your machine needs service or repair.• The external housing of your machine has been damaged.• Do not incinerate spilled toner or used toner. Toner dust might ignite when exposed to an open flame.• Disposal can take place at our authorized dealer.• Dispose of the used toner cartridge in accordance with the local regulations. |
|------------------------------------------------------------------------------------------------------------------------------------------------------------------------------------------------------------------------------------------------------------------------------------------------------------------------------------------------------------------------------------------------------------------------------------------------------------------------------------------------------------------------------------------------------------------------------------------------------------------------------------------------------------------------------------------------------------------------------------------------------------------------------------------------------------------------------------------------------------------------------------------------------------------------------------------------------------------------------------------------------------------------------------------------------------------------------------------------------------------------------------------|

⚠ CAUTION:

- *Protect the machine from dampness or wet weather, such as rain and snow.*
- *Unplug the power cord from the wall outlet before you move the machine. While moving the machine, you should take care that the power cord will not be damaged under the machine. Unplug the power cord from the wall outlet before you move the machine. While moving the machine, you should take care that the power cord will not be damaged under the machine.*
- *When you disconnect the power plug from the wall outlet, always pull the plug (not the cable).*
- *Do not allow paper clips, staples, or other small metallic objects to fall inside the machine.*
- *Keep toner (used or unused) and toner cartridge out of the reach of children.*
- *For environmental reasons, do not dispose of the machine or expended supply waste at household waste collection points. Disposal can take place at an authorized dealer.*
- *The inside of the machine could be very hot. Do not touch the parts with a label indicating "⚠" (means hot surface). Touching "⚠" (means hot surface) could result in a burn.*
- *Our products are engineered to meet high standards of quality and functionality, and we recommend that you use only the expendable supplies available at an authorized dealer.*

Positions of Labels and Hallmarks for ⚠WARNING and ⚠CAUTION

This machine has labels for ⚠WARNING and ⚠CAUTION at the positions shown below. For safety, please follow the instructions and handle the machine as indicated.

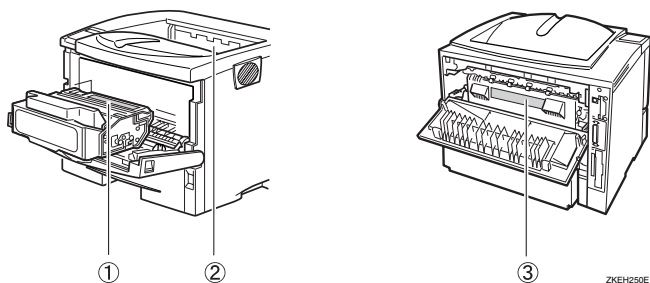

①

 <p>WARNING ATTENTION WARNUNG AVVISO AVISO ADVERTENCIA 警告</p>	 <ul style="list-style-type: none"> ● Do not incinerate toner or toner containers. Toner dust may cause flashback when exposed to an open flame. ● Ne pas incinérer les cartouches ni les boîtes de cartouches de toner. Exposée à une flamme nue, la cendre de toner peut provoquer un retour de flamme. ● Verbrennen Sie keinen Toner oder Tonerkartusche. Tonerstaub kann beim kontakt mit offenem Feuer explodieren.

②

			PET ^ v
-----------------------------------------------------------------------------------	-----------------------------------------------------------------------------------	-----------------------------------------------------------------------------------	---------------

③

 <p>CAUTION ACHTUNG ATTENTION ATTENTION</p>	<p>PRECAUCIÓN ATTENZIONE 高温注意</p>	 <ul style="list-style-type: none"> ●High temperature. ●Hohe Temperatur. ●Temperature leve. 	<ul style="list-style-type: none"> ●Alta temperatura. ●Temperatura elevada. ●高温になっています。
			

ENERGY STAR Program

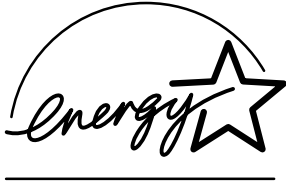

ENERGY STAR®

As an ENERGY STAR Partner, we have determined that this machine model meets the ENERGY STAR Guidelines for energy efficiency.

The ENERGY STAR Guidelines intend to establish an international energy-saving system for developing and introducing energy-efficient office equipment to deal with environmental issues, such as global warming.

When a product meets the ENERGY STAR Guidelines for energy efficiency, the Partner shall place the ENERGY STAR logo onto the machine model.

This product was designed to reduce the environmental impact associated with office equipment by means of energy-saving features, such as Low-power mode.

- **Energy Saver mode**

This printer automatically lowers its power consumption 15 minutes after the last operation has been completed. To exit Energy Saver mode, press any key on the control panel. To change the setting of the Energy Saver mode, see “*System Menu*” in the Printer Reference on the CD-ROM labeled “Operating Instructions”.

◆ **Specifications**

Energy Saver mode	Power Consumption	<ul style="list-style-type: none"> • Basic model: With Options: 7W or less Printer Only: 4W
	Default Time	15 minutes

◆ **Recycled Paper**

In accordance with the ENERGY STAR Program, we recommend use of recycled paper which is environment friendly. Please contact your sales representative for recommended paper.

Manuals for This Printer

Manuals for This Printer

The following manuals describe the operational procedures and maintenance of this machine.

To enhance safe and efficient operation of this printer, all users should read and follow the instructions carefully.

◆ **Quick Installation Guide**

Describes how to install the printer.

◆ **Setup Guide (this manual)**

Provides information about setting up the printer and its options. This manual is provided as a printed manual, and also on the CD-ROM labeled "Operating Instructions".

◆ **Printer Reference**

Provides information about using the printer and its options. This manual is provided on the CD-ROM labeled "Operating Instructions".

◆ **Network Printing Guide**

Provides information about setting up and using the printer in a network environment. This manual is provided on the CD-ROM labeled "Operating Instructions".

◆ **PostScript 3 Operating Instructions Supplement**

Describes the menus and features for the PostScript 3 printer driver. This manual is provided on the CD-ROM labeled "Operating Instructions".

 **Note**

- There are three CD-ROMs that come with this printer. "Operating Instructions", "Printer Drivers and Utilities", and "Document Management Utility".
- Concerning UNIX information, please visit our Web site or consult your authorized reseller.

How to Read This Manual

Symbols

In this manual, the following symbols are used:

WARNING:

This symbol indicates a potentially hazardous situation which, if instructions are not followed, could result in death or serious injury.

CAUTION:

This symbol indicates a potentially hazardous situation which, if instructions are not followed, may result in minor or moderate injury or damage to property.

* The statements above are notes for your safety.

Important

If this instruction is not followed, paper might be misfed, originals might be damaged, or data might be lost. Be sure to read this.

Preparation

This symbol indicates the prior knowledge or preparations required before operating.

Note

This symbol indicates precautions for operation, or actions to take after misoperation.

Limitation

This symbol indicates numerical limits, functions that cannot be used together, or conditions in which a particular function cannot be used.

Reference

This symbol indicates a reference.

[]

Keys that appear on the machine's panel display.

Keys and buttons that appear on the computer's display.

[]

Keys built into the machine's control panel.

Keys on the computer's keyboard.

1. Getting Started

Printer Drivers for This Printer

Printing requires installation of a printer driver for your operating system. The following drivers are included on the CD-ROM that comes with this printer.

Operating system	Printer Language	PCL 6	PCL 5e	RPCS	PostScript 3
Windows 95 ^{*1}		√	√	√	√ ^{*9}
Windows 98 ^{*2}		√	√	√	√ ^{*9}
Windows Me ^{*3}		√	√	√	√ ^{*9}
Windows 2000 ^{*4}		√	√	√	√ ^{*9}
Windows XP/Server 2003 ^{*5}		√	√	√	√ ^{*9}
Windows NT 4.0 ^{*6}		√	√	√	√ ^{*8} ^{*9}
Mac OS/Mac OS X ^{*7}					√ ^{*9}

^{*1} Microsoft Windows 95 operating system

^{*2} Microsoft Windows 98 operating system

^{*3} Microsoft Windows Millennium Edition

^{*4} Microsoft Windows 2000 Advanced Server

Microsoft Windows 2000 Professional

Microsoft Windows 2000 Server

^{*5} Microsoft Windows XP Professional

Microsoft Windows XP Home Edition

Windows Server 2003 Standard Edition

Windows Server 2003 Enterprise Edition

Windows Server 2003 Web Edition

^{*6} Microsoft Windows NT Server operating system version 4.0, Microsoft Windows NT Workstation operating system version 4.0 in a computer using x86 processors.

^{*7} Requires Mac OS 8.6 or later / Mac OS X 10.1 or later.

^{*8} Requires Service Pack 4 or later.

^{*9} The Adobe PostScript printer drivers and PostScript Printer Description (PPD) files are included on the CD-ROM labeled "Printer Drivers and Utilities".

❖ PCL printer drivers

Printer drivers allow the computer to communicate with the printer via a printer language. Two kinds of PCL printer drivers, PCL 6 and PCL 5e, are provided with this printer. We recommend PCL 6 as your first choice.

Note

- Some of your applications might require the installation of the PCL 5e printer driver. In this case, you can install PCL 5e in addition to PCL 6. See p.62 "Installing the PCL 6/5e Printer Driver"

❖ **RPCS printer driver**

This printer driver allows the computer to communicate with the printer via a printer language. The preset type user interface is provided in addition to the conventional one.

See p.65 “Installing the RPCS Printer Driver”

❖ **Adobe PostScript Printer Drivers and PPD files**

The Adobe PostScript printer drivers and PPD files are included on the CD-ROM that comes with this printer. Adobe PostScript printer driver allows the computer to communicate with the printer via a printer language. The PPD files allow the printer driver to enable the printer specific functions.

See p.68 “Windows 95/98/Me - Installing the PostScript Printer Driver”

See p.70 “Windows 2000/Windows XP/Server 2003 - Installing the PostScript Printer Driver”

See p.72 “Windows NT 4.0 - Installing the PostScript Printer Driver”

Software and Utilities Included on the CD-ROM

1

There are three CD-ROMs that come with this printer. These are labeled "Operating Instructions", "Printer Drivers and Utilities" and "Document Management Utility". The following are included on the three separate CD-ROMs.

❖ **Font Manager 2000**

Helps you to install new screen fonts, or organize and manage fonts already installed on the system. This is included on the CD-ROM labeled "Printer Drivers and Utilities".

❖ **SmartNetMonitor for Admin**

A utility for the system administrator to manage printers on the network. This is included on the CD-ROM labeled "Printer Drivers and Utilities".

Reference

See SmartNetMonitor for Admin online Help for more information about using SmartNetMonitor for Admin.

❖ **SmartNetMonitor for Client**

A utility for users to manage their own print status on the network. This is included on the CD-ROM labeled "Printer Drivers and Utilities".

Reference

See SmartNetMonitor for Client online Help for more information about using SmartNetMonitor for Client.

❖ **Acrobat Reader**

A utility that allows you to read PDF (Portable Document Format). This is included on the CD-ROM labeled "Operating Instructions".

Note

- Documentation about using the printer is included on the CD-ROM in PDF format. See Acrobat Reader online Help for more information about using Acrobat Reader.

Important

- If you upgrade to Windows 2000 from Windows 95/98/Me or Windows NT 4.0, the software and utilities must be uninstalled prior to installing Windows 2000. Then reinstall them in a Windows 2000 environment.

Viewing the Contents of the CD-ROM

Follow the steps to view the contents of the CD-ROM.

1 Insert the CD-ROM into the CD-ROM drive.

Auto Run will start the installer.

2 Click [**Browse This CD-ROM**].

Explorer starts and displays the contents of the CD-ROM.

Guide to This Printer

Mainframe

1

◆ Exterior

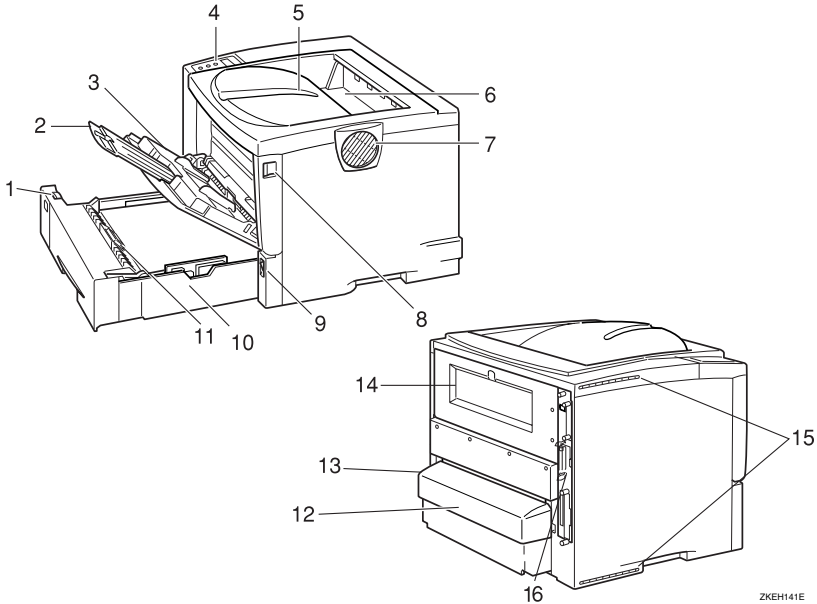

1. Paper Size Dial

Adjust this dial to match the size and feed direction of the paper loaded in the paper tray.

2. Bypass Tray Extension

Pull out this extension to load paper into the Bypass Tray when its length is longer than B5□.

3. Bypass Tray

Use to print onto thick paper, OHP transparencies, adhesive labels, envelopes as well as plain paper. When printing on custom paper size, printer driver settings are required.

Up to 100 sheets of plain paper (80 g/m², 20 lb. bond) can be loaded.

See *"Paper and Other Media Supported by this Printer"* and *"Loading Paper in the Bypass Tray"* in the Printer Reference on the CD-ROM labeled "Operating Instructions".

4. Control Panel

Contains keys for the printer operation and a panel display that shows the printer status.

5. Output Tray (Standard Tray)

Printed output is stacked here with the print side facing down.

6. Upper Cover

Remove to install the optional 1-bin Shift Sort Tray or the optional Mailbox.

7. Ventilator

This hole helps to keep components inside the printer from overheating.

Important

- Do not block or obstruct the ventilator. A malfunction may occur due to overheating.

8. Front Cover Release Button

Use this button to open the front cover.

9. Power Switch

Use this switch to turn the printer power on and off.

10. Paper Tray (Tray 1)

Loads up to 500 sheets of plain paper (80 g/m², 20 lb. bond) into this tray for printing.

See *"Paper and Other Media Supported by this Printer"* in the Printer Reference on the CD-ROM labeled "Operating Instructions".

Note

- Paper Tray is displayed "Tray 1" on the panel display.
- Optional paper feed units appear as "Tray 2" and "Tray 3" on the panel display (when two units are installed).

11. Friction pad

This is required to feed in paper one sheet at a time. Clean the friction pad when more than one sheet of paper is fed into the printer. Also, replace the friction pad when the message, "Replace Maintenance Kit", appears.

12. Paper Tray Cover

This is installed on the back of the printer.

13. Power Cord

Plug the power cord into a wall outlet.

14. Rear Cover

Remove to install the optional Duplex Unit or to replace the Fusing Unit.

15. Ventilators

These holes help to keep components inside the printer from overheating.

Important

- Do not block or obstruct the ventilators. A malfunction may occur due to overheating.

16. Controller Board

Slide this out to install certain options. A parallel interface cable, USB cable, Ethernet cable, 1394 interface cable and other options are connected via the corresponding slots.

◆ Interior

[Front side]

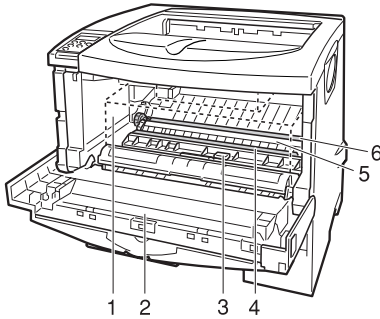

1. Toner Cartridge

Includes toner and a photoconductor unit.

When "Replace Toner Cartridge" appears on the panel display, replace this unit.

2. Front Cover

Open this cover when accessing the inside of the printer.

3. Guide Board

Open this board to remove misfed paper.

4. Registration Roller

Feeds the paper. If it becomes dirty, clean it.

See "Cleaning the Registration Roller", *Printer Reference* on the CD-ROM labeled "Operating Instructions".

[Back side]

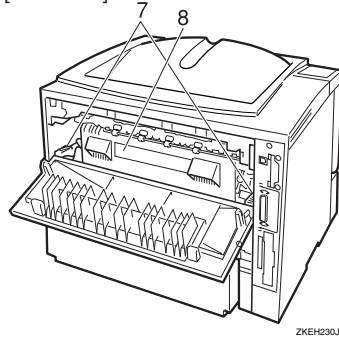

5. Transfer Roller Cover

Open this cover when replacing a transfer roller.

6. Transfer Roller

When "Replace Maintenance Kit" appears on the panel display, replace this roller.

7. Fusing Unit Lock Levers

Lift these levers when replacing the fusing unit.

8. Fusing Unit

Fuses the image onto paper.

When "Replace Maintenance Kit" appears on the panel display, replace this unit.

Control Panel

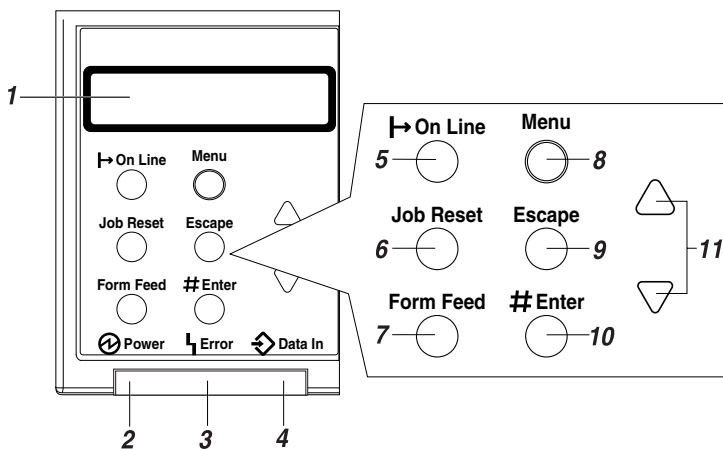

ZKES100N

1. Panel display

Shows the current status of the printer and error messages.

See “*Error & Status Messages on the Control Panel*” in the Printer Reference on the CD-ROM labeled “Operating Instructions”.

2. Power indicator

Is on while the printer power is on.

Is off when the power is turned off or while the printer is in Energy Saver mode.

3. Error indicator

Blinks or lights up whenever any printer error occurs. A message describing the cause of the error also appears on the panel display.

See “*Error & Status Messages on the Control Panel*” in the Printer Reference on the CD-ROM labeled “Operating Instructions”.

4. Data In indicator

Blinks while the printer is receiving data from a computer.

Is on if there is data to be printed.

5. [On Line] key

Press this key to switch the printer between online and offline.

6. [Job Reset] key

When the printer is online, press this key to cancel any ongoing print job.

See “*Canceling a Print job*” in the Printer Reference on the CD-ROM labeled “Operating Instructions”.

7. [Form Feed] key

If the printer is offline, press this key to print all the data left in the printer’s input buffer.

Note

This does not work if the printer is online.

8. [Menu] key

Press this key to make and check the current printer settings.

See “*Making Printer Settings with the Control Panel*” in the Printer Reference on the CD-ROM labeled “Operating Instructions”.

9. [Escape] key

Press this key to return to the previous condition on the panel display.

10. [Enter #] key

Press this key to execute menu items selected on the panel display.

Press this key to clear some errors.

See "Troubleshooting", *Printer Reference* on the CD-ROM labeled "Operating Instructions".

11. [▲][▼] keys

Use these keys to increase or decrease values on the panel display when making settings.

2. Installing Options

CAUTION:

- *Be sure to turn off the printer and wait for about an hour before installing options. Not waiting for the printer to cool down can result in a burn.*
- *When lifting the printer, use the inset grips on both sides of the printer, otherwise the printer might fall and cause personal injury.*
- *When you move the printer, unplug the power cord from the wall outlet to avoid a fire or an electric shock.*

Important

- The voltage rating of the connector for options is 24V DC or less.
- Turn the power off before removing the Paper Feed Unit Type 400. Removing the Paper Feed Unit Type 400 with the power on may cause the printer to fail.

Option List

Note

- See the inside front cover of this manual to confirm which printer (Basic model or Network standard model) you have.

	Basic model Printer	Network standard model Printer
Paper Feed Unit Type 400	<input type="radio"/>	<input type="radio"/>
Envelope Feeder Type 400	<input type="radio"/>	<input type="radio"/>
AD450 (Duplex Unit)	<input type="radio"/>	<input type="radio"/>
Memory Unit Type C (SDRAM Module)	<input type="radio"/>	<input type="radio"/>
Hard Disk Drive Type 2600	<input type="radio"/>	<input type="radio"/>
Network Interface Board Type 2610 ^{*1}	<input type="radio"/>	
1394 Interface Unit Type 4510 ^{*1 *2}	<input type="radio"/>	<input type="radio"/>
802.11b Interface Unit Type A ^{*1 *2}	<input type="radio"/>	<input type="radio"/>
Bluetooth Interface Unit Type 2045 ^{*1 *2}	<input type="radio"/>	<input type="radio"/>

: Available option

^{*1} With Basic model, these cannot be installed at the same time.

^{*2} With Network standard model, these cannot be installed at the same time.

Note

- A maximum of two Paper Feed Units can be attached to the printer at the same time.
- The installation of the Paper Feed Unit is necessary to attach the Envelope Feeder Unit.
- You must install additional Memory Units to use the 1394 Interface Unit and Bluetooth Interface Unit.

Available Options

The following options can be attached to the printer.

◆ Exterior

2

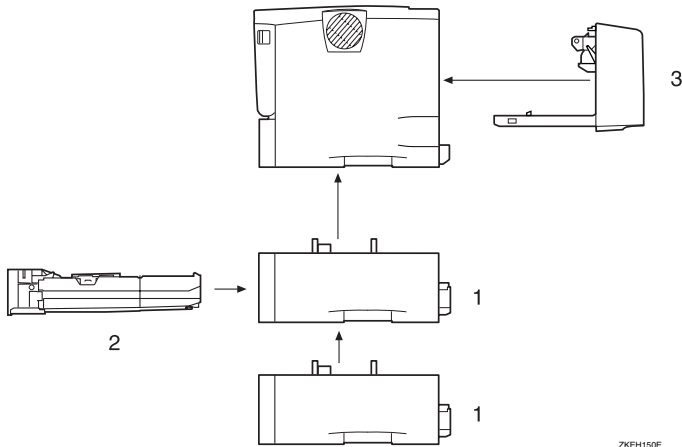

ZKEH150E

1. Paper Feed Unit Type 400 (Tray 2 or Tray 3)

You can load up to 500 sheets (60-105g/m², 16-28 lb.bond) of plain paper into the tray.

✎ Note

- A maximum two Paper Feed Units Type 400 can be attached.
- Top-most optional Paper Feed Unit is displayed "Tray 2" and bottom-most is displayed "Tray 3" on the panel display.

2. Envelope Feeder Type 400

You can load up to 60 envelopes (72-90g/m², 19-24 lb.bond) into the tray.

✎ Note

- The Envelope Feeder is a tray that slides into the optional Paper Feed Unit. Without the optional Paper Feed Unit, the Envelope Feeder cannot be used.
- Your Printer can have two optional Paper Feed Units installed at the same time. The Envelope Feeder Unit can be used in either "Tray 2" or "Tray 3".

3. AD450 (Duplex Unit)

You can print on both sides of paper. Install the Duplex Unit by removing the rear cover of the printer.

◆ Basic model Printer : Interior

Note

- See the inside front cover of this manual to confirm which printer (Basic model or Network standard model) you have.

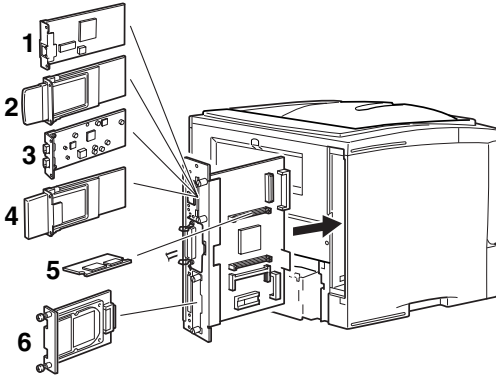

ZKEX010E

1. Network Interface Board Type 2610

You can perform the print job on the network environment.

Note

- The Network Interface Board, the 1394 Interface Unit, the 802.11b Interface Unit, and the Bluetooth Interface Unit cannot be installed in the printer at the same time.

2. 802.11b Interface Unit Type A

You can perform the print job on the IEEE 802.11b (Wireless LAN) environment.

Note

- The Network Interface Board, the 1394 Interface Unit, the 802.11b Interface Unit, and the Bluetooth Interface Unit cannot be installed in the printer at the same time.

3. 1394 Interface Unit Type 4510

You can perform the print job on the IEEE 1394 environment.

Note

- The Network Interface Board, the 1394 Interface Unit, the 802.11b Interface Unit, and the Bluetooth Interface Unit cannot be installed in the printer at the same time.

4. Bluetooth Interface Unit Type 2045

The printer can be used as a Bluetooth™ printing device.

5. Memory Unit Type C (SDRAM Module)

There are three types of Memory Unit: 64 MB, 128 MB and 256 MB. This enables memory to be expanded up to 320 MB when combined with the standard 64 MB Memory Unit.

6. Hard Disk Drive Type 2600

You can use the “Collate”, the “Sample Print” and the “Locked Print” functions.

❖ Network standard model Printer : Interior

Note

- ❑ See the inside front cover of this manual to confirm which printer (Basic model or Network standard model) you have.

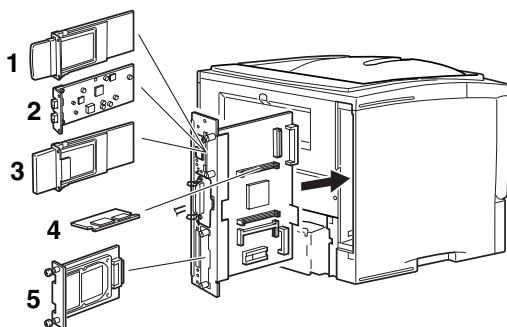

ZKEX011E

1. 802.11b Interface Unit Type A

You can perform the print job on the IEEE 802.11b (Wireless LAN) environment.

Note

- ❑ The 1394 Interface Unit, the 802.11b Interface Unit, and the Bluetooth Interface Unit cannot be installed in the printer at the same time.

2. 1394 Interface Unit Type 4510

You can perform the print job on the IEEE 1394 environment.

Note

- ❑ The Network Interface Board, the 1394 Interface Unit, the 802.11b Interface Unit, and the Bluetooth Interface Unit cannot be installed in the printer at the same time.

3. Bluetooth Interface Unit Type 2045

The printer can be used as a Bluetooth™ printing device.

4. Memory Unit Type C (SDRAM Module)

There are three types of Memory Unit: 64 MB, 128 MB and 256 MB. This enables memory to be expanded up to 320 MB when combined with the standard 64 MB Memory Unit.

5. Hard Disk Drive Type 2600

You can use the “Collate”, the “Sample Print” and the “Locked Print” functions.

Paper Feed Unit Type 400

⚠ CAUTION:

- The printer weighs about 17 kg (37.5 lbs.).
- When lifting the machine, use the inset grips on both sides. Otherwise the printer could break or cause injury if dropped.

🔧 Important

- ❑ Do not slide more than one paper tray out at the same time. Having more than one full paper tray fully extended could cause the machine to topple.
- ❑ More than two Paper Feed Units Type 400 cannot be attached.
- ❑ Check the printer nameplate to confirm the model code.

1 Check the contents of the box for the following items:

- Paper Feed Unit (including a paper tray)
- Installation Guide

2 Confirm that the followings are true:

- The power switch is turned off.
- The power cord is unplugged from the wall outlet.

3 Remove the adhesive tape from the Paper Feed Unit.

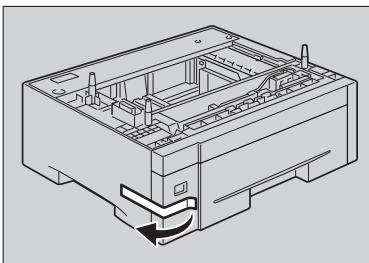

ZKEX390E

🔧 Note

- ❑ If you attach two Paper Feed Units at the same time, stack them up in advance.

- 4** There are three pins on the top of the Paper Feed Unit that point straight up. On the bottom of the printer there are three holes. Align the holes over the pins, and then lower the printer gently onto the Paper Feed Unit.

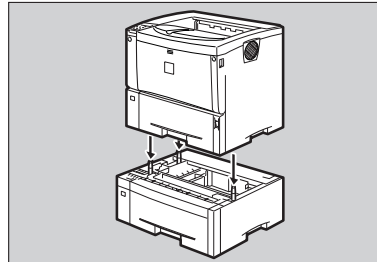

ZKEX400E

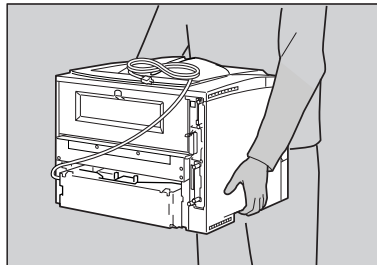

ZKEH221E

- 5** Attach the interface cable to the printer.

- 6** Plug the printer's power cord back into the wall outlet, and then turn on the power switch.

 **Note**

- ❑ After installing the last option that you want, print the configuration page to confirm the installation. If the new device is listed in the column of configuration options, then it has been properly installed. For more information about printing the configuration page, see *"Printing the Configuration Page"* in the Printer Reference on the CD-ROM labeled "Operating Instructions".
- ❑ If the Paper feed unit is not installed properly, repeat the procedure from step 2. If you cannot install it properly even after reinstallation, contact your sales or service representative.

 **Reference**

For information about loading paper, see *"Loading Paper in the Optional Paper Tray"* in the Printer Reference on the CD-ROM labeled "Operating Instructions".

If the printing position is not correct, adjust the registration of the trays. For more information about adjusting the registration of the trays, see *"Adjusting the Registration of the Trays"* in the Printer Reference.

Envelope Feeder Type 400

Note

- ❑ This unit is a tray that slides into the optional Paper Feed Unit. Without the optional Paper Feed Unit, this Envelope Feeder cannot be used.
- ❑ Your printer can accommodate two optional Paper Feed Units. The Envelope Feeder Unit can be used in "Tray 2". Neither the main unit's feed tray (Tray 1) nor Tray 3 can be used for this purpose.

Important

- ❑ Do not slide more than one paper tray out at the same time. Having more than one full paper tray fully extended could cause the machine to topple.

The following explanation uses the example of installing the Envelope Feeder Unit in "Tray 2".

1 Check the contents of the box for the following items:

- Envelope Feeder
- Installation Guide

2 Pull out the second paper tray (Tray 2) of the optional Paper Feed Unit until it stops. After that, lift it slightly, and then pull it out.

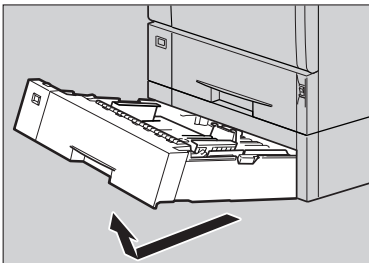

ZKEP330E

Important

- ❑ The tray of the top-most optional Paper Feed Unit is beneath the paper tray.

Note

- ❑ Keep the paper tray with paper in a cool dark place.

3 Lift the front of the Envelope Feeder, and slide it carefully into the printer until it stops.

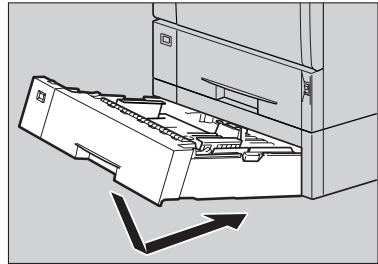

ZKEP340E

Reference

For information about loading paper, see "Loading Envelopes" in the Printer Reference on the CD-ROM labeled "Operating Instructions".

Memory Unit Type C (SDRAM Module)

Important

- Before touching the Memory Unit, touch something metal to discharge any static electricity. Static electricity can damage the Memory Unit.
- Do not subject the Memory unit to physical shocks.

1 Check the contents of the box for the following items:

- Memory Unit
- Installation Guide

2 Confirm that the followings are true:

- The power switch is turned off.
- The interface cable is unplugged from the printer.

3 Remove the two screws holding the controller board in place.

Note

- Use a coin or similar object if the screws do not turn easily.
- The removed screws are required in step 11.

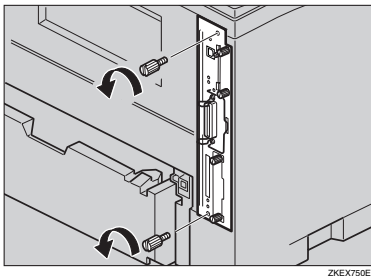

4 Pull out the handle of the controller board.

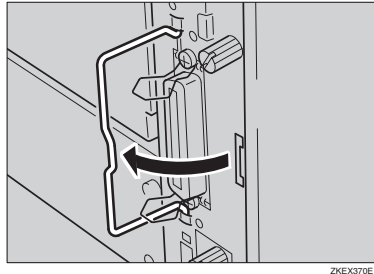

5 Holding the handle, slowly pull out the controller board.

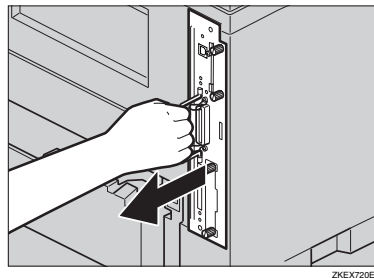

6 Place the controller board on a flat surface.

7 The Memory Unit is installed in the slot shown in the illustration below.

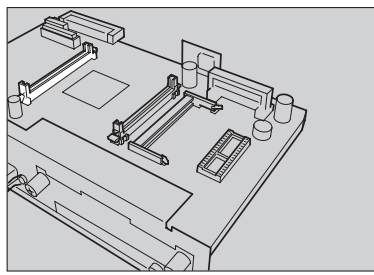

- 8** Insert the Memory unit to the slot by placing the notch of the unit to the projection of the slot, and then push it down until it clicks.

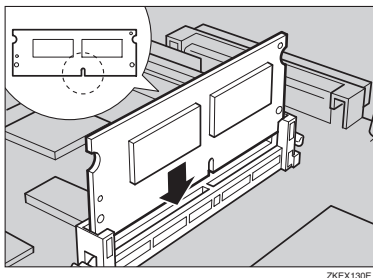

- 9** Match the controller board to the top and bottom rail using the "▼" mark, and then slide it into the printer slowly until it stops.

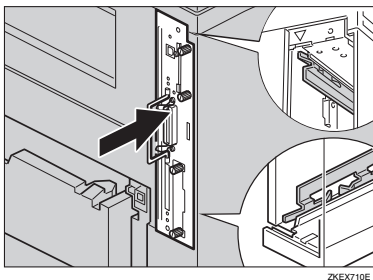

- 10** Push the handle of the controller board until it clicks.

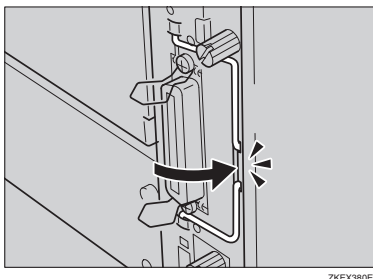

- 11** Fasten the controller board to the printer with the two screws.

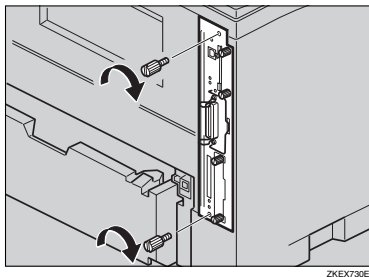

- 12** Attach the interface cable to the printer.

- 13** Plug the printer's power cord back into the wall outlet, and then turn on the power switch.

Important

- If you use a Windows operating system, you should set up the Memory Unit with the printer driver to make the printer recognize the installation. See the description of Windows 95/98/Me, Windows 2000, Windows XP/Server 2003 and Windows NT 4.0 on p.59 "Installing the Printer Driver and Software".

Note

- After installing the last option that you want, print the configuration page to confirm the installation. If the new device is listed in the column of configuration options, then it has been properly installed. For more information about printing the configuration page, see "Printing the Configuration Page" in the Printer Reference on the CD-ROM labeled "Operating Instructions".

- ❑ If the Memory Unit is properly, "Total Memory" will be the total size of the standard Memory Unit plus the expanded Memory Unit. The total values of Memory Units are as shown below.

Standard	Extended	Total
64MB	64MB	128MB
	128MB	192MB
	256MB	320MB

- ❑ If the Memory unit is not installed properly, repeat the procedure from step 2. If you cannot install it properly even after reinstallation, contact your sales or service representative.
- ❑ To remove the Memory Unit, press the button on the end of the slot.

Network Interface Board Type 2610

Note

- Depending on the model you use, the Network Interface Board, the 1394 Interface Unit, the 802.11b Interface Unit, and the Bluetooth Interface Unit cannot be installed to the printer at the same time. For more information, see p.19 "Installing Options".

Important

- Before touching the Network Interface Board, touch something metal to discharge any static electricity. Static electricity can damage the Network Interface Board.
- Do not subject the Network interface board to physical shocks.
- Use the shielded twisted-pair (STP) network interface cable.

Installing the Network Interface Board

- 1** Check the contents of the box for the following items:

- Network Interface Board
- Ferrite Core
- Installation Guide

- 2** Confirm that the followings are true:

- The power switch is turned off.
- The interface cable is unplugged from the printer.

Note

- The interface cable is not included in the box. Make sure that the interface cable you use is appropriate for your computer.

- 3** Remove the two screws holding the controller board in place.

Note

- Use a coin or similar object if the screws do not turn easily.
- These screws are used again in step 12.

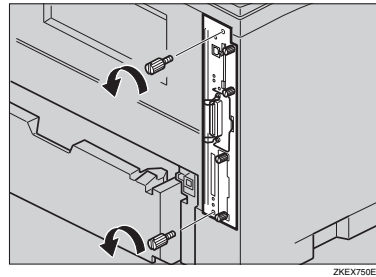

- 4** Pull out the handle of the controller board.

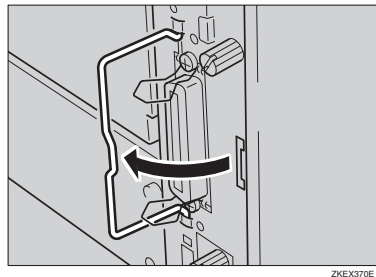

- 5** Holding the handle, slowly pull out the controller board.

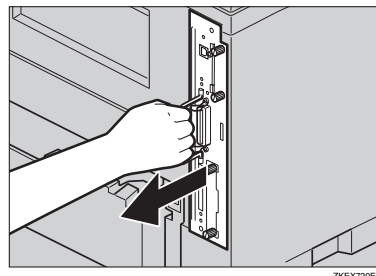

6 Place the controller board on a flat surface.

7 Remove the two screws and the cover of the Network Interface Unit mounting bracket.

Note

- ❑ These screws are used again in step **9**.
- ❑ The removed cover is not used when installing the Network Interface Board.

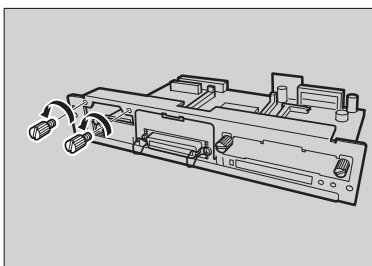

ZKEX041E

8 Insert the end of the Network Interface Board into the opening (1), and then push down until it clicks (2).

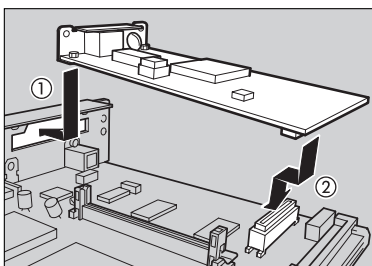

ZKEX422E

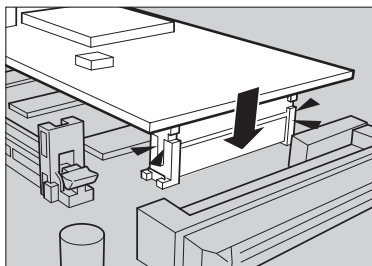

ZKEX432E

9 Fasten the Network Interface Board to the controller board.

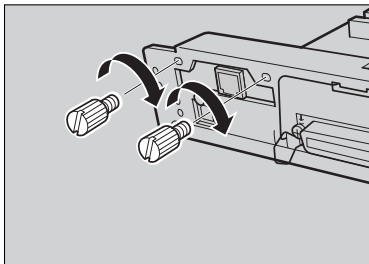

ZKEX444E

10 Match the controller board to the top and bottom rail using the "▼" mark, and then slide it into the printer slowly until it stops.

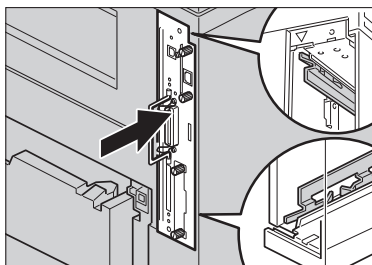

ZKEX254E

11 Push back the handle of the controller board until it clicks.

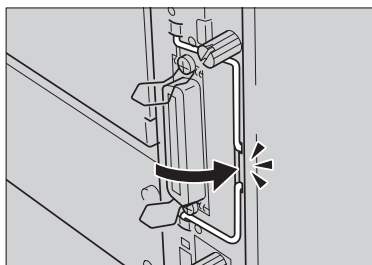

ZKEX381E

- 12** Fasten the controller board to the printer with the two screws.

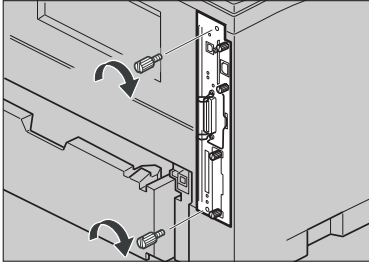

- 13** Attach the interface cable to the printer.

- 14** Plug the printer's power cord back into the wall outlet, and then turn on the power switch.

Note

- After installing the last option that you want, print the configuration page to confirm the installation. If the information about network settings (e.g. IP address) is listed in the configuration page, then it has been properly installed. For more information about printing the configuration page, see "Printing the Configuration Page" in the Printer Reference on the CD-ROM labeled "Operating Instructions".
- If the Network interface board is not installed properly, repeat the procedure from step **2**. If you cannot install it properly even after reinstallation, contact your sales or service representative.

Connecting the Network Interface Cable to the Network

- 1** Turn off the power switch.
- 2** Loop the network interface cable and attach the ferrite core.

Note

- The network interface cable loop should be about 15 cm (6") (①) from the end of the cable (on the end closest to the printer). The ferrite core at the end of the cable should be a ring type ferrite core.

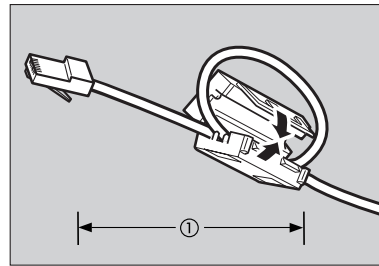

- 3** Attach the network interface cable to the jack on the Network Interface Unit.

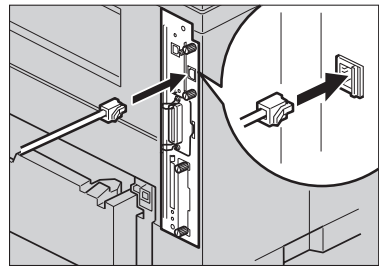

- 4** Connect the other end of the network interface cable to the network.

5 Turn on the power switch.

Check the LEDs on the ethernet port.



- — 1
- — 2

ZGDH260J

1 is lit when the printer is securely connected to the network.

2 is lit when 100BASE-TX is in use and not lit when 10BASE-T is in use.

1394 Interface Unit Type 4510

Note

- ❑ Depending on the model you use, the Network Interface Board, the 1394 Interface Unit, 802.11b Interface Unit, and the Bluetooth Interface Unit cannot be installed to the printer at the same time. For more information, see p.19 “Installing Options”.

Important

- ❑ Printing using “1394/SCSI Printer” (Windows 2000) device and “IEEE 1394 and SCSI printers” (Windows XP/Server 2003) with the optional 1394 interface unit is possible under Windows 2000 and Windows XP/Server 2003. Printing with IP over 1394 is possible under Windows Me and Windows XP/Server 2003.
- ❑ With Windows 2000, the 1394 Interface Unit can only be used with Service Pack 1 or later. If the Service Pack is not installed, the connectable SCSI print device in a 1394 bus is only one, and the client cannot install the printer driver without using an account with Administrators permission.
- ❑ Before touching the 1394 Interface Unit, touch something metal to discharge any static electricity. Static electricity can damage the 1394 Interface Unit.
- ❑ Do not subject the 1394 interface unit to physical shocks.
- ❑ Unplug all the interface cables from the printer before installation. If you take out the controller board with cables plugged in, the 1394 Interface Unit might be damaged.

- ❑ Use the 1394 interface cable that comes with this printer.
- ❑ Do not plug or unplug the 1394 interface cable while installing the printer driver.

Note

- ❑ Refer to the manual provided with the 1394 Interface Unit for further details.

Installing the 1394 Interface Unit

1 Check the contents of the box for the following items:

- 1394 Interface Unit
- 1394 Interface Cable (6 pins x 4 pins)
- 1394 Interface Cable (6 pins x 6 pins)
- Installation Guide
- Notes to Users

2 Confirm that the followings are true:

- The power switch is turned off.
- The interface cable is unplugged from the printer.

3 Remove the two screws holding the controller board in place.

Note

- Use a coin or similar object if the screws do not turn easily.
- These screws are used again in step 12.

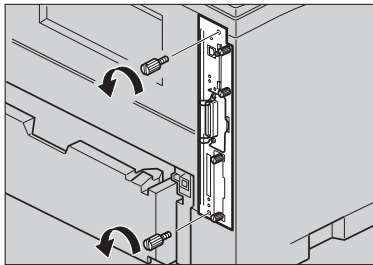

ZKEX750E

4 Pull out the handle of the controller board.

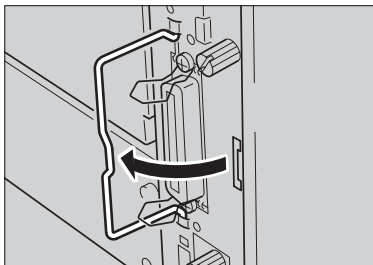

ZKEX370E

5 Holding the handle, slowly pull out the controller board.

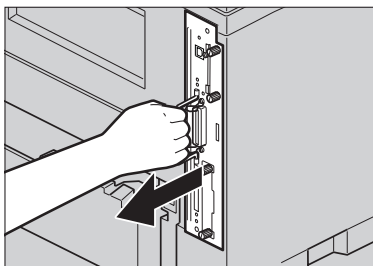

ZKEX720E

6 Place the controller board on a flat surface.

7 Remove the two screws and the cover of the 1394 Interface Unit mounting bracket.

Note

- These screws are used again in step 9.
- The removed cover is not used when installing the 1394 Interface Unit.

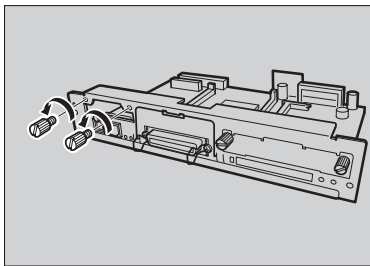

ZKEX040E

8 Attach the 1394 Interface Unit to the controller board.

Insert the end of the 1394 Interface Unit into the opening (1), and then push down until it clicks (2).

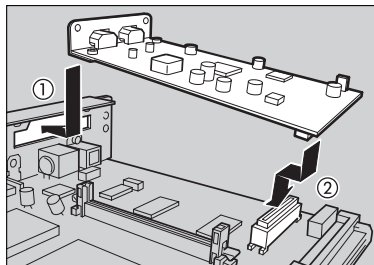

ZKEX421E

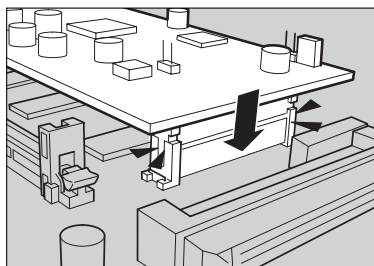

ZKEX430E

- 9** Fasten the 1394 Interface Unit to the controller board.

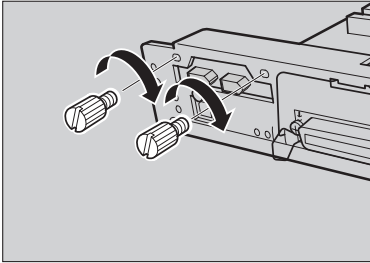

ZKEX443E

- 12** Fasten the controller board to the printer with the two screws.

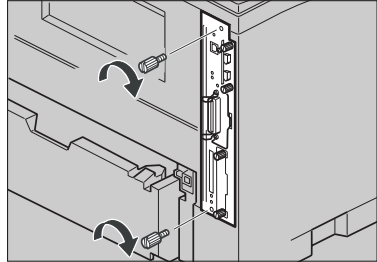

ZKDX274J

- 10** Match the controller board to the top and bottom rail using the "▼" mark, and then slide it into the printer slowly until it stops.

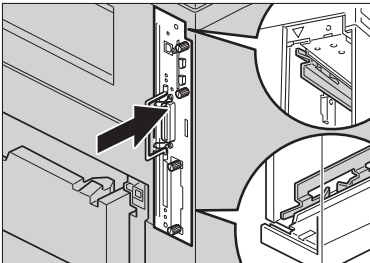

ZKEX252E

- 11** Push back the handle of the controller board until it clicks.

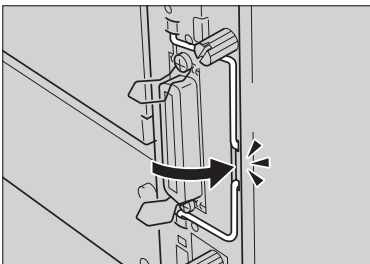

ZKEX380E

- 13** Attach the interface cable to the printer.

- 14** Plug the printer's power cord back into the wall outlet, and then turn on the power switch.

Note

- After installing the last option that you want, print the configuration page to confirm the installation. If the new device is listed in the column of configuration options, then it has been properly installed. For more information about printing the configuration page, see "Printing the Configuration Page" in the Printer Reference on the CD-ROM labeled "Operating Instructions".
- If the 1394 interface unit is not installed properly, repeat the procedure from step 2. If you cannot install it properly even after reinstallation, contact your sales or service representative.
- You need to make settings with the control panel before using the 1394 Interface Unit. ⇒ p.54 "IEEE 1394 Configuration"

Connecting the 1394 Interface Cable to the Printer

- 1 Attach the 1394 interface cable to the jack on the 1394 Interface Unit.

Note

- Both types of jack are available.
- If you have an interface cable with a ferrite core, connect the end nearest to the ferrite core to the printer.

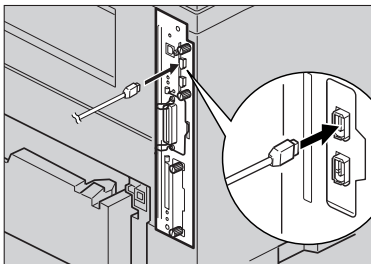

ZKDX550J

- 2 Connect the other end of the 1394 interface cable to the computer or the other IEEE 1394 node.

1394 Interface Unit specifications

- ❖ **Interface Connector:**
IEEE 1394 (6 pins × 2)
- ❖ **Required cable:**
1394 interface cable (6 pins × 4 pins, 6 pins × 6 pins)
- ❖ **Important**
 - You cannot plug devices together to create loops.
 - Do not use a cable more than 4.5 meters (14.8 feet) long.
- ❖ **Connectable number of devices in a bus:**
Maximum 63
- ❖ **Allowed cable hops in a bus:**
Maximum 16
- ❖ **Power supply:**
Nonpower supply
Cable Power repeated (IEEE 1394a-2000 compliant)

802.11b Interface Unit Type A

Note

- Depending on the model you use, the Network Interface Board, the 1394 Interface Unit, 802.11b Interface Unit, and the Bluetooth Interface Unit cannot be installed to the printer at the same time. For more information, see p.19 "Installing Options".

Important

- Before touching the 802.11b Interface Unit, touch something metal to discharge any static electricity. Static electricity can damage the 802.11b Interface Unit.
- Do not subject the 802.11b interface unit to physical shocks.

1 Check the contents of the box for the following items:

- 802.11b Interface Unit
- Card
- Antenna Cap
- Installation Guide

2 Confirm that the followings are true:

- The power switch is turned off.
- The interface cable is unplugged from the printer.

3 Remove the two screws holding the controller board in place.

Note

- Use a coin or similar object if the screws do not turn easily.

- These screws are used again in step 8.

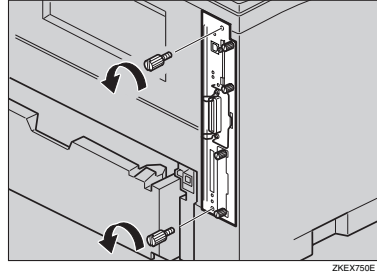

4 Pull out the handle of the controller board.

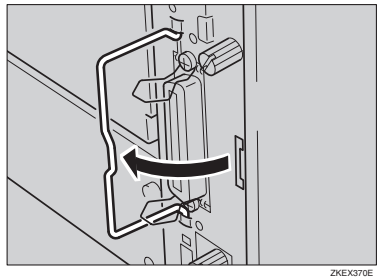

5 Holding the handle, slowly pull out the controller board.

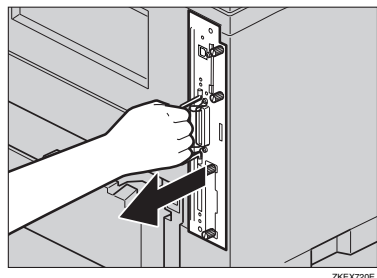

6 Place the controller board on a flat surface.

7 Remove the two screws and the cover of the 802.11b Interface Unit mounting bracket.

Note

- ❑ These screws are used again in step **9**.
- ❑ The removed cover is not used when installing the 802.11b Interface Unit.

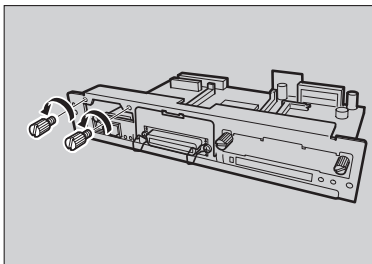

ZKEX040E

8 Attach the 802.11b Interface Unit.

Insert the end of the 802.11b Interface Unit into the opening (1), and then push down until it clicks (2).

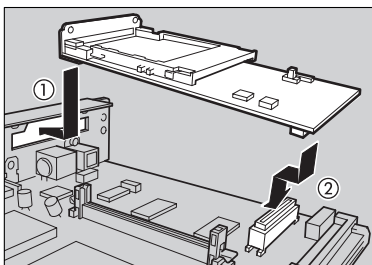

ZKEX420E

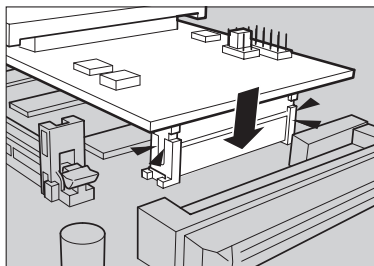

ZKEX431E

9 Fasten the 802.11b Interface Unit to the controller board with the two screws.

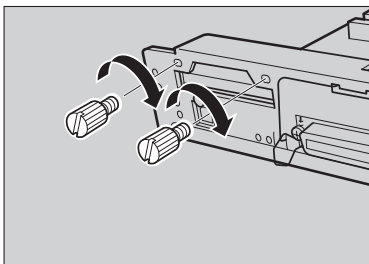

ZKEX442E

10 Insert the card slowly into the 802.11b board with the label facing down and the uneven black antenna surface facing up until it stops.

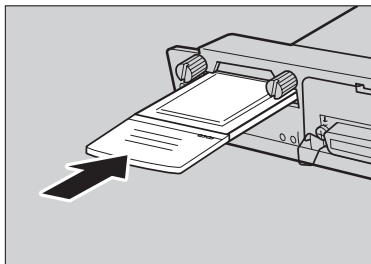

ZKEX500E

11 Match the controller board to the top and bottom rail using the "▼" mark, and then slide it into the printer slowly until it stops.

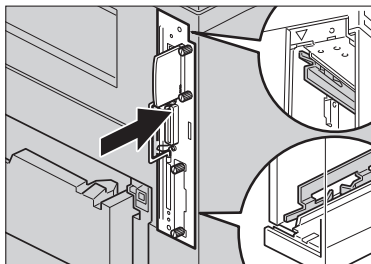

ZKEX251E

- 12** Push back the handle of the controller board until it clicks.

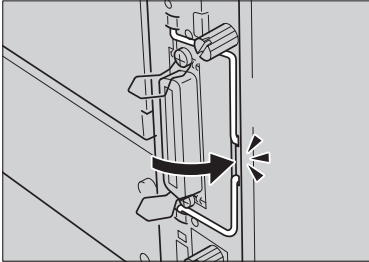

ZKEX380E

- 13** Fasten the controller board to the printer with the two screws.

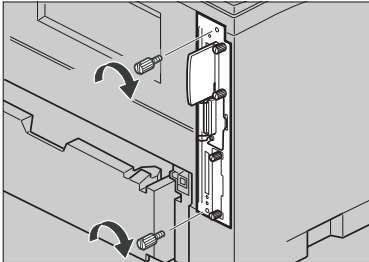

ZKEX273E

- 14** Attach the antenna cap to the card with the side that has both corners of the antenna cap cut out facing the screws.

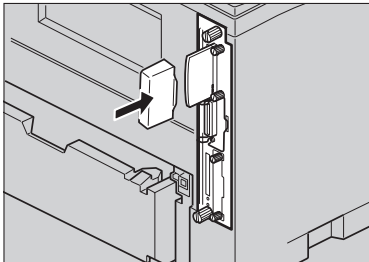

ZKEX275E

- 15** Attach the interface cable to the printer.

- 16** Plug the printer's power cord back into the wall outlet, and then turn on the power switch.

You need to make settings with the control panel before using the 802.11b Interface Unit.

Note

- After installing the last option that you want, print the configuration page to confirm the installation. If the new device is listed in the column of configuration options, then it has been properly installed. For more information about printing the configuration page, see "Printing the Configuration Page" in the Printer Reference on the CD-ROM labeled "Operating Instructions".
- If the 802.11b interface unit is not installed properly, repeat the procedure from step 2. If you cannot install it properly even after reinstallation, contact your sales or service representative.
- You need to make settings with the control panel before using the 802.11b Interface Unit. ⇒ p.57 "IEEE 802.11b (Wireless LAN) Configuration"

Bluetooth Interface Unit Type 2045

Note

- Depending on the model you use, the Network Interface Board, the 1394 Interface Unit, 802.11b Interface Unit, and the Bluetooth Interface Unit cannot be installed to the printer at the same time. For more information, see p.19 "Installing Options".

Important

- Before touching the Bluetooth Interface Unit, touch something metal to discharge any static electricity. Static electricity can damage the Bluetooth Interface Unit.
- Do not subject the Bluetooth interface unit to physical shocks.

Limitation

- You must install additional Memory Units to use the Bluetooth Interface Unit. See p.26 "Memory Unit Type C (SDRAM Module)"

1 Check the contents of the box for the following items:

- Bluetooth Interface Unit
- Card
- Antenna Cap
- Installation Guide

2 Confirm that the followings are true:

- The power switch is turned off.
- The interface cable is unplugged from the printer.

3 Remove the two screws holding the controller board in place.

Note

- Use a coin or similar object if the screws do not turn easily.
- These screws are used again in step 8.

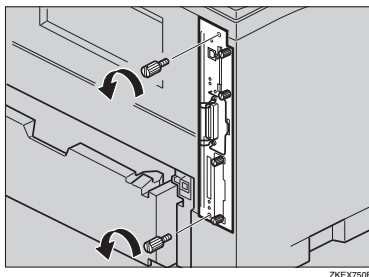

4 Pull out the handle of the controller board.

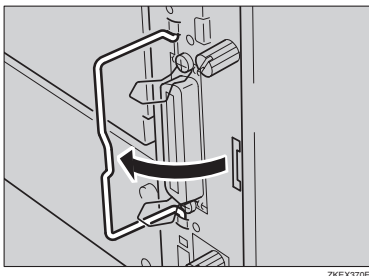

5 Holding the handle, slowly pull out the controller board.

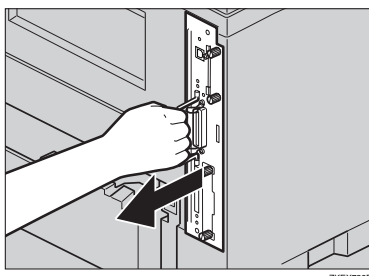

6 Place the controller board on a flat surface.

7 Remove the two screws and the cover of the Bluetooth Interface Unit mounting bracket.

 **Note**

- These screws are used again in step **9**.
- The removed cover is not used when installing the Bluetooth Interface Unit.

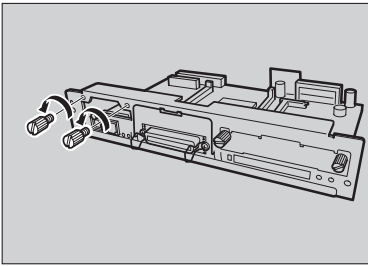

ZKEX040E

8 Attach the Bluetooth Interface Unit.

Insert the end of the Bluetooth Interface Unit into the opening (①), and then push down until it clicks (②).

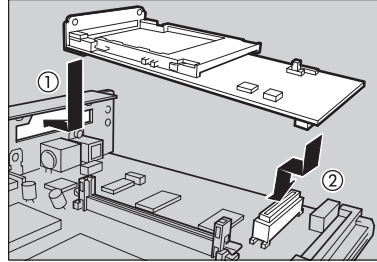

ZKEX420E

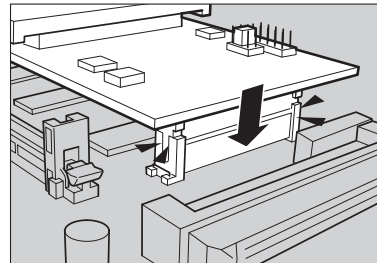

ZKEX431E

9 Fasten the Bluetooth Interface Unit to the controller board with the two screws.

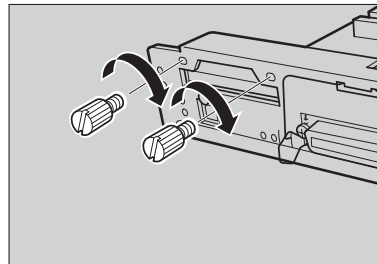

ZKEX442E

2

- 10** With the side labeled INSERT facing up, slowly insert the card into the Bluetooth unit, until it stops.

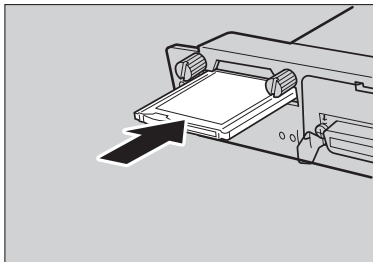

ZKEX070E

- 11** Match the controller board to the top and bottom rail using the "▼" mark, and then slide it into the printer slowly until it stops.

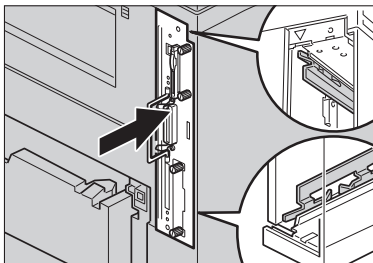

ZKEX080E

- 12** Push back the handle of the controller board until it clicks.

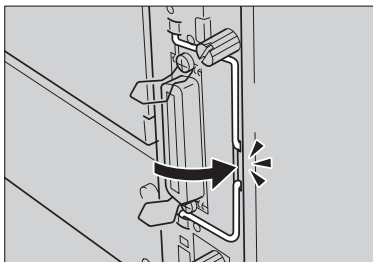

ZKEX380E

- 13** Fasten the controller board to the printer with the two screws.

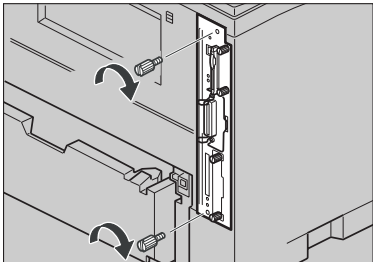

ZKEX274E

- 14** Press the antenna to extend it.

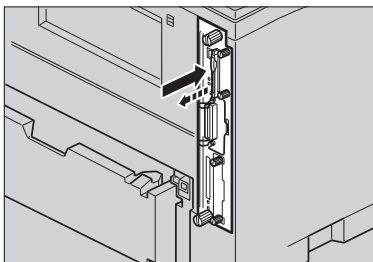

ZKEX090E

- 15** Attach the antenna cap to the card with the side that has both corners of the antenna are cut out facing the screws.

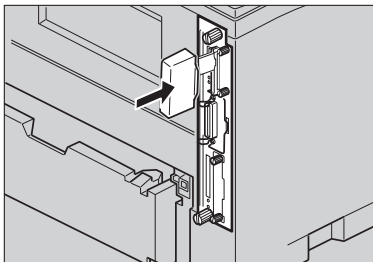

ZKEX340E

- 16** Attach the interface cable to the printer.

- 17** Plug the printer's power cord back into the wall outlet, and then turn on the power switch.

 **Note**

- After installing the last option that you want, print the configuration page to confirm the installation. If the new device is listed in the column of configuration options, then it has been properly installed. For more information about printing the configuration page, see "*Printing the Configuration Page*" in the Printer Reference on the CD-ROM labeled "Operating Instructions".
- If the Bluetooth interface unit is not installed properly, repeat the procedure from step **17**. If you cannot install it properly even after reinstallation, contact your sales or service representative.

Hard Disk Drive Type 2600

Important

- ❑ Before touching the Hard Disk Drive, touch something metal to discharge any static electricity. Static electricity can damage the Hard Disk Drive.

1 Check the contents of the box for the following items:

- Hard Disk Drive
- Installation Guide

2 Confirm that the followings are true:

- The power switch is turned off.
- The interface cable is unplugged from the printer.

3 Remove the two screws and the cover of the Hard Disk Drive mounting bracket.

Note

- ❑ The screws and cover are not used when installing the Hard Disk Drive.

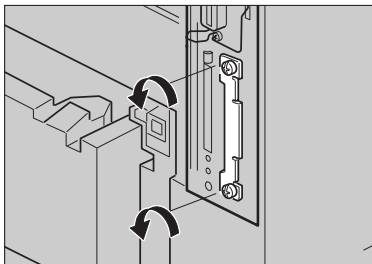

4 Slowly insert the Hard Disk Drive while aligning it with the top and bottom rails in the printer until it stops.

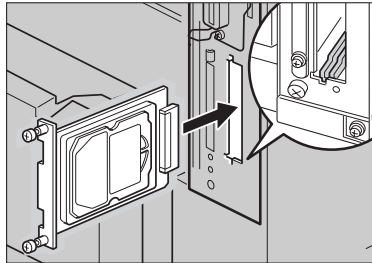

5 Fasten the two screws (using a coin, etc.) to fix the Hard Disk Drive.

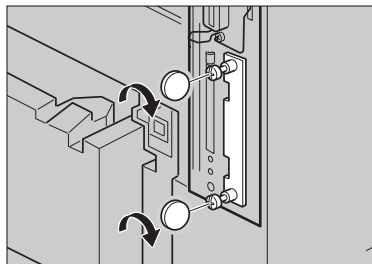

6 Attach the interface cable to the printer.

7 Plug the printer's power cord back into the wall outlet, and then turn on the power switch.

 **Important**

- ❑ If you use a Windows operating system, you should set up the Hard Disk Drive with the printer driver to make the printer recognize the installation. See a description of Windows 95/98/Me, Windows 2000, Windows XP/Server 2003 and Windows NT 4.0 on p.59 "Installing the Printer Driver and Software".

 **Note**

- ❑ After installing the last option that you want, print the configuration page to confirm the installation. If the new device is listed in the column of configuration options, then it has been properly installed. For more information about printing the configuration page, see "*Printing the Configuration Page*" in the Printer Reference on the CD-ROM labeled "Operating Instructions".
- ❑ If the Hard disk drive is not installed properly, repeat the procedure from step 2. If you cannot install it properly even after reinstallation, contact your sales or service representative.

AD450 (Duplex Unit)

Important

- If you attach the Duplex Unit and the Paper Feed Unit, the Paper Feed Unit must be attached prior to attaching the Duplex Unit.
- Check the printer nameplate to confirm the model code.

1 Check the contents of the box for the following items:

- Duplex Unit
- Installation Guide

2 Confirm that the followings are true:

- The power switch is turned off.

3 Remove the adhesive tape and paper.

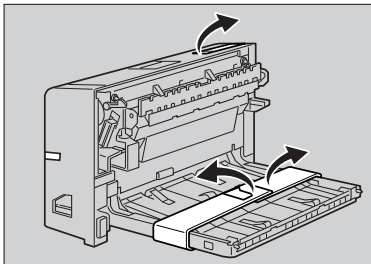

ZKEX650E

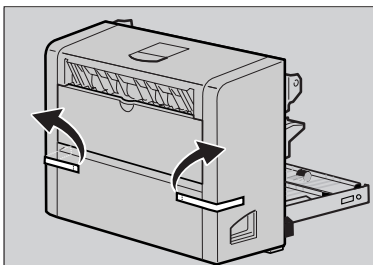

ZKEX651E

4 Place a finger in the printer's rear cover finger-hole (upper center) and pull it open.

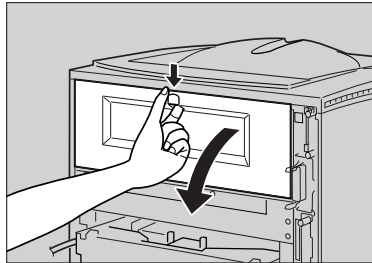

ZKEX610E

5 Remove the rear cover in the horizontal direction.

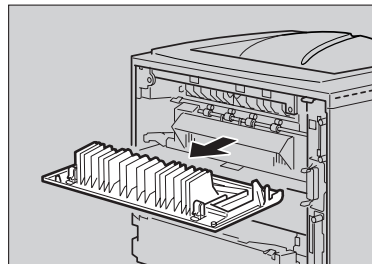

ZKEX620E

Note

- The rear cover of the printer is not used when attaching the Duplex Unit.
- Store the removed rear cover for possible future use.
- Proceed to step 7 if the paper tray cover is not installed.

- 6** Pull the bottom of the paper tray cover (①) up slightly, and then remove the paper tray cover (②), in the order shown in the illustration.

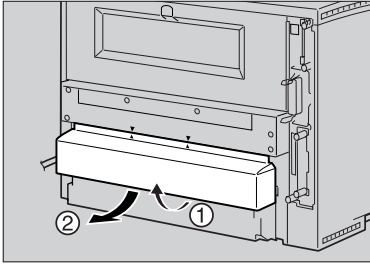

- 7** Push in the Duplex Unit along the rails at the back of the printer.

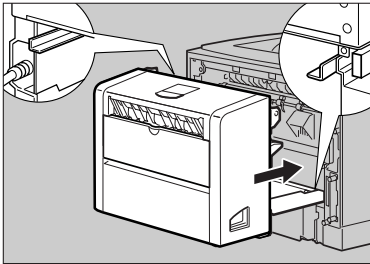

- 8** Push the Duplex Unit securely into the printer.

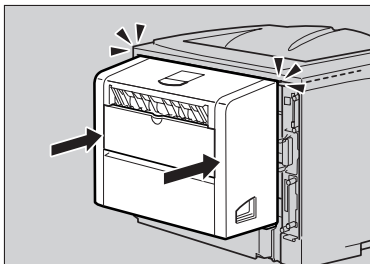

- 9** Attach the interface cable to the printer.

- 10** Plug the printer's power cord back into the wall outlet, and then turn on the power switch.

Note

- After installing the last option that you want, print the configuration page to confirm the installation. If the new device is listed in the column of configuration options, then it has been properly installed. For more information about printing the configuration page, see "Printing the Configuration Page" in the Printer Reference on the CD-ROM labeled "Operating Instructions".
- If the Duplex unit is not installed properly, repeat the procedure from step 2. If you cannot install it properly even after reinstallation, contact your sales or service representative.
- If the printing position is not correct, adjust the registration of the trays. For more information about adjusting the registration of the trays, see "Adjusting the Registration of the Trays" in the Printer Reference.

2

3. Configuring the Printer for the Network

Make the network settings below depending on the network interface you use.

- Parallel/USB: Making network settings is not necessary. Go to p.59 "Installing the Printer Driver and Software".
- Ethernet: Make the settings in p.49 "Ethernet Configuration", and then see p.59 "Installing the Printer Driver and Software".
- IEEE 1394: Make the settings in p.54 "IEEE 1394 Configuration", and then see p.59 "Installing the Printer Driver and Software".
- Wireless LAN: Make the settings in p.57 "IEEE 802.11b (Wireless LAN) Configuration", and then see p.59 "Installing the Printer Driver and Software".

Note

- The optional Network Interface Board is necessary to use Ethernet with Basic model printer.
- The optional 1394 Interface Unit is necessary to use IEEE 1394.
- The optional 802.11b Interface Unit is necessary to use the wireless LAN.
- The optional Bluetooth Interface Unit is necessary to use Bluetooth™.

Ethernet Configuration

Configure the printer for the network using the printer's control panel.

The following table shows the control panel settings and their default values. These items are included in the "Host Interface" menu.

Reference

For information about configuring the computer for the network, see the Network Printing Guide on the CD-ROM labeled "Operating Instructions".

For information about "Host Interface" menu, see "Host Interface Menu" in the Printer Reference on the CD-ROM labeled "Operating Instructions".

Setting Name	Value	
DHCP	On	
IP Address *1	011.022.033.044	
Subnet Mas k *1	000.000.000.000	
Gateway Address *1	000.000.000.000	
Frame Type (NW) (Frame type NetWare)	Auto	
Active Protocol	TCP/IP	<input type="radio"/> *2
	NetWare	<input type="radio"/> *2
	NetBEUI	<input type="radio"/> *2
	AppleTalk	<input type="radio"/> *2
Ethernet *3	Auto	
LAN Type *4	Ethernet	

*1 If DHCP is in use, the IP address, subnet mask, and gateway address are all set automatically.

*2 means that this protocol is active.

*3 Make this setting only when it is necessary.

*4 Appears only when both the Network Interface Board and the 802.11b Interface Unit are installed.

1 Press **[Menu]**.

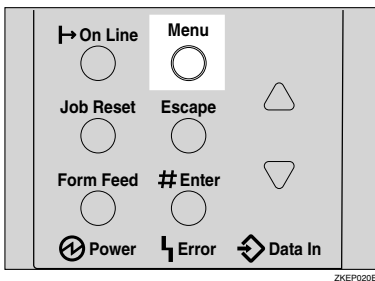

“Menu” appears on the panel display.

2 Press **[▲]** or **[▼]** to display “Host Interface” menu.

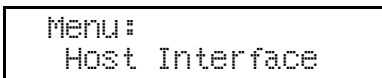

3 Press **[Enter #]**.

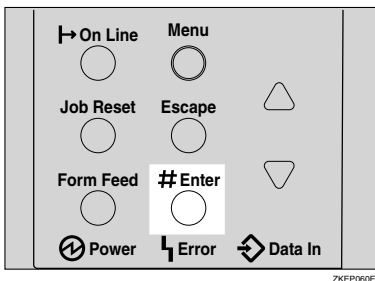

The following message appears on the panel display.

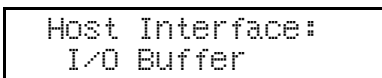

4 Press **[▲]** or **[▼]** to display “Network Setup”.

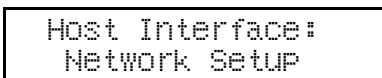

5 Press **[Enter #]**.

The following message appears on the panel display.

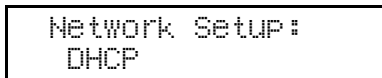

6 Select the protocol you want to use.

Note

Do not select protocols that are not used on your network.

1 Press **[▲]** or **[▼]** to display “Active Protocol”.

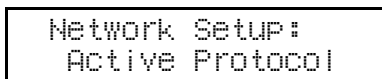

2 Press **[Enter #]**.

The current setting appears on the panel display.

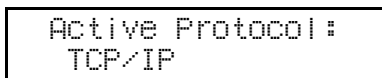

3 Press **[Enter #]**.

4 Press **[▲]** or **[▼]** to select "Active" or "Not Active", and then press **[Enter #]**.

5 Set other protocols you need to set in the same way.

Note

Leave unused protocols "Not Active".

Enable TCP/IP to use the Pure IP environment of NetWare 5/5.1.

- 7** When you use this machine in DHCP environment, proceed to step **10**. When you use this machine with a fixed IP address, you must make the setting for the required item after setting DHCP to Off. Proceed to step **8**.

Important

- When DHCP is On, you cannot make settings for the following items:
 - IP Address
 - Subnet Mask
 - Gateway Address

Consult your network administrator for information about making network settings.

- 8** Set DHCP to Off.

- 1** Press **[▲]** or **[▼]** to display “DHCP”, and then press **[Enter #]**.

```
Network Setup:
  DHCP
```

- 2** Press **[▲]** or **[▼]** to display “Off”, and then press **[Enter #]**.

```
DHCP:
*Off
```

Note

- * shows the current setting.
- After about two seconds, the display returns to the “Network Setup” setting screen.

- 9** If you use TCP/IP, assign the IP address to the printer.

Note

- To get the IP address for the printer, contact your network administrator.

- 1** Press **[▲]** or **[▼]** until the following message appears.

```
Network Setup:
  IP Address
```

- 2** Press **[Enter #]**.

The current IP address appears on the panel display.

```
IP Address:
  000.000.000.000
```

- 3** Press **[▲]** or **[▼]** to enter the left most entry field of the IP address.



```
IP Address:
  192.000.000.000
```

- 4** Press **[Enter #]**.

The pointer () moves to the next entry field automatically.

```
IP Address:
  192.00█.000.000
```

Note

- The value moves by 10 if **[▲]** or **[▼]** is kept pressed.
- When **[Enter #]** is pressed, the cursor moves to the next field.
- You can return the pointer () to the previous (left) entry field by pressing **[Escape]**.
- If you press **[Escape]** when the pointer () is on the left-most position, the selected IP address is reset.

- 5 Repeat steps 3 and 4 to enter the IP address.

```
IP Address:
 192.168.000.011
```

Check if the pointer (█) is at the rightmost position, and press **[Enter #]** to register the IP address you selected.

```
Network Setup:
 IP Address
```

- 10 If you use TCP/IP, assign "Subnet Mask" and "Gateway Address" following the same procedure for entering the IP address.

- 11 If you use NetWare, select the frame type for NetWare.

Select one of the items below if necessary.

- Auto (Default)
- Ethernet II
- Ethernet 802.2
- Ethernet 802.3
- Ethernet SNAP

 **Note**

Usually, use the default setting ("Auto"). When you first select "Auto", the frame type detected by the printer is adopted. If your network can use more than two frame types, the printer may fail to select the correct frame type if "Auto" is selected. In this case, select the appropriate frame type.

- 1 Press **[▲]** or **[▼]** to display "Frame Type (NW)".

```
Network Setup:
 Frame Type (NW)
```

- 2 Press **[Enter #]**.

The current setting appears on the panel display.

```
Frame Type (NW):
 *Auto
```

- 3 Press **[▲]** or **[▼]** to display the frame type you want to use.

- 4 Press **[Enter #]**.

- 12 Select the interface.

Ethernet and IEEE 802.11b appear only when both the Network Interface Board and the 802.11b Interface Unit are installed.

Select one of the items below.

- Ethernet
- IEEE 802.11b

- 1 Press **[▲]** or **[▼]** to display "LAN Type".

```
Network Setup:
 LAN Type
```

- 2 Press **[Enter #]**.

The current setting appears on the panel display.

- 3 Press **[▲]** or **[▼]** to display "Ethernet".

```
LAN Type:
 *Ethernet
```

- 4 Press **[Enter #]**.

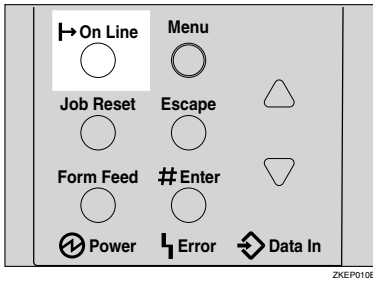
13 Press **[On Line]**.

"Ready" appears on the panel display.

**14** Print a configuration page to confirm the settings made. See *"Printing a Configuration Page"* in the Printer Reference.

The settings are now complete. Go to p.59 "Installing the Printer Driver and Software".

IEEE 1394 Configuration

Use this procedure to configure the printer for use in the IEEE 1394 environment. The following table shows the control panel settings and their default values. These items are included in the "Host Interface" menu.

Setting Name	Value
DHCP	On
IP Address1394 *1	000.000.000.000
Subnet Mask1394 *1	000.000.000.000
IP over 1394	Active
SCSI print	Active
Bidi-SCSI print	On

*1 If DHCP is in use, IP address1394 and Subnet Mask1394 are automatically set.

Depending on the protocol you use, procedures vary. See the following table.

IP over 1394	Steps 0-00 and then go to steps 00 to 00
SCSI print	Steps 0-0 and then go to steps 00 to 00

1 Press [Menu].

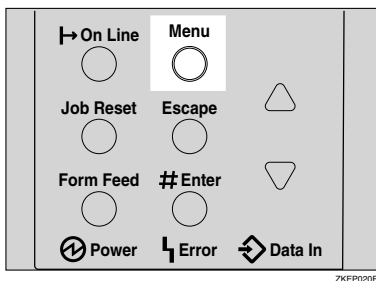

"Menu" appears on the panel display.

2 Press [▲] or [▼] to display "Host Interface" menu.

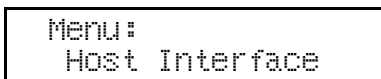

3 Press [Enter #].

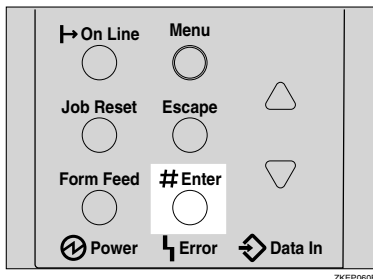

The following message appears on the panel display.

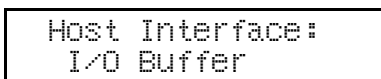

4 Press [▲] or [▼] to display "IEEE 1394 Setup".

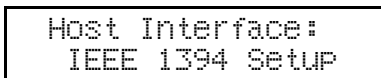

5 Press [Enter #].

The following message appears on the panel display.

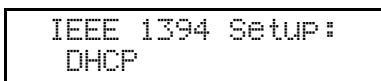

- 6** Press **[▲]** or **[▼]** to display “IP over 1394”.

```
IEEE 1394 Setup:
IP over 1394
```

- 1** Press **[Enter #]**.
- 2** Press **[▲]** or **[▼]** to select either "Active" or "Not Active".
- 3** Press **[Enter #]**.

The display returns to the previous menu in a few seconds.

- 7** When you use this machine in DHCP environment, proceed to step**8**. When you use this machine with a fixed IP address, you must make the setting for the required item after setting DHCP to Off. Proceed to step**8**.

Important

- When DHCP is On, you cannot make settings for the following items:
 - IP Address1394
 - Subnet Mask1394

Consult your network administrator for information about making network settings.

- 8** Set DHCP to Off.

- 1** Press **[▲]** or **[▼]** to display “DHCP”, and then press **[Enter #]**.

```
IEEE 1394 Setup:
DHCP
```

- 2** Press **[▲]** or **[▼]** to display “Off”, and then press **[Enter #]**.

```
DHCP:
*Off
```

Note

- * shows the current setting.
- After about two seconds, the display returns to the “IEEE 1394 Setup” setting screen.

- 9** Assign the IP address to the printer.

Limitation

- Do not overlap the IP address in the same subnet or the same IP address in the network setting.

Note

- To get the IP address for the printer, contact your network administrator.

- 1** Press **[▲]** or **[▼]** until the following message appears.

```
IEEE 1394 Setup:
IP Address1394
```

- 2** Press **[Enter #]**.

The current IP address appears on the panel display.

```
IP Address1394:
011.022.033.044
```

- 3** Press **[▲]** or **[▼]** to enter the leftmost entry field of the IP address.

```
IP Address1394:
192.000.000.000
```

- 4** Press **[Enter #]**.

The pointer () moves to the next entry field automatically.

```
IP Address1394:
192.00█.000.000
```

Note

- The value moves by 10 if **[▲]** or **[▼]** is kept pressed.
- You can return the pointer (▣) to the previous (left) entry field by pressing **[Escape]**.
- If you press **[Escape]** when the pointer (▣) is on the left-most position, the selected IP address is reset.

5 Repeat steps 3 and 4 to enter the IP address.

```
IP Address1394:
 192.168.000.011
```

Check if the pointer (▣) is at the rightmost position, and press **[Enter #]** to register the IP address you selected.

```
IEEE 1394 Setup:
 IP Address1394
```

10 Set "Subnet Mask1394" in the same way.

11 Set "SCSI print" and "Bidi-SCSI print" if necessary.

Note

- The default setting is "Active".

12 Press [▲] or [▼] to display "SCSI print".

```
IEEE 1394 Setup:
 SCSI Print
```

13 Press [Enter #].

The following message appears on the panel display.

```
SCSI Print:
 *Active
```

14 Press [▲] or [▼] to select either "Active" or "Not Active", and then press [Enter #].

Set "Bidi-SCSI print" in the same way.

15 Press [On Line].

"Ready" appears on the panel display.

```
Ready
```

16 Print a configuration page to confirm the settings made. See "Printing a Configuration Page" in the Printer Reference.

The settings are now complete. Go to p.59 "Installing the Printer Driver and Software".

IEEE 802.11b (Wireless LAN) Configuration

Configure the printer for using the wireless LAN. The following table shows the control panel settings and their default values. These items are included in the "Host Interface" menu.

Setting Name	Value
Comm. Mode	802.11 Ad hoc
Channel	<ul style="list-style-type: none"> Inch version (1-11) 11 Metric version (1-13) 11
Trans. Speed	Auto
WEP Setting	Not Active

In order to use the wireless LAN, select "IEEE 802.11b" for "LAN Type" in "Network Setup" of the Host Interface menu, and then set "DHCP", "IP Address", "Subnet Mask", "Gateway Address", "Frame Type (NW)" and "Active Protocol" in the "Network Setup". For more information about setting the items in the "Network Setup", see p.49 "Ethernet Configuration".

1 Press [Menu].

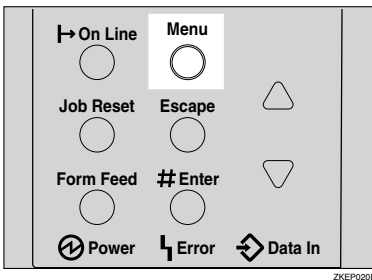

"Menu" appears on the panel display.

The following message appears on the panel display.

2 Press [▲] or [▼] to display "Host Interface" menu.

```
Menu:
Host Interface
```

3 Press [Enter #].

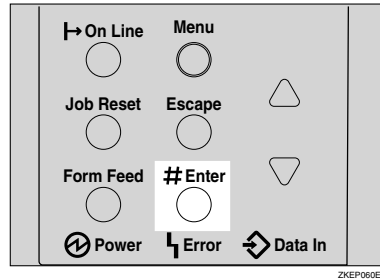

The following message appears on the panel display.

```
Host Interface:
I/O Buffer
```

4 Press [▲] or [▼] to display "IEEE 802.11b".

```
Host Interface:
IEEE 802.11b
```

5 Press [Enter #].

Be sure that "Comm. Mode" appears on the panel display.

```
IEEE 802.11b:
Comm. Mode
```

6 Press [Enter #].

```
Comm. Mode:
*802.11 Ad hoc
```

7 Press **[▲]** or **[▼]** to select the transmission mode.

8 Press **[Enter #]**.

The display returns to the previous menu in a few seconds.

9 Set "Trans. Speed" and "WEP Setting" in the same way.

For more information about WEP Settings, see "Using the IEEE 802.11b (Wireless LAN)" in the Network Printing Guide.

10 If "802.11 Ad hoc" or "Ad hoc" is selected for "Comm. Mode", set the channel for transmission.

 **Note**

- Select "802.11b Ad hoc" for SSID input. Select "Ad hoc" when SSID input is not required for the computer's wireless LAN setting.
- Confirm the network administrator for the channel to use.

1 Press **[▲]** or **[▼]** to display "Channel".

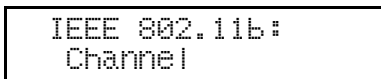

2 Press **[Enter #]**.

The channel currently used appears on the panel display.

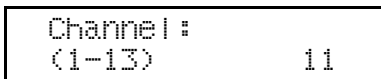

3 Press **[▲]** or **[▼]** to enter the channel.

4 Press **[Enter #]**.

11 Press **[On Line]**.

"Ready" appears on the panel display.



12 Print a configuration page to confirm the settings made. See "Printing a Configuration Page" in the Printer Reference.

The settings are now complete. Go to p.59 "Installing the Printer Driver and Software".

 **Address**

◆ Subnet Mask

A number used to mathematically "mask" or hide an IP address on the network by eliminating those parts of the address that are alike for all the machines on the network.

◆ Gateway Address

A gateway is a connection or interchange point that connects two networks. A gateway address is for the router or host computer used as a gateway.

 **Note**

- To get the addresses, contact your network administrator.

4. Installing the Printer Driver and Software

This manual assumes that you are familiar with general Windows procedures and practices. If you are not, see the documentation that comes with Windows for details.

Installation Method

The following table shows how to install the printer drivers and software.

	Auto Run ^{*1}		
	Quick Install		Custom installation ^{*2}
	Network connection with TCP/IP	Parallel connection	
PCL 6 printer driver	<input type="radio"/>	<input type="radio"/>	<input type="radio"/>
PCL 5e printer driver			<input type="radio"/>
RPCS printer driver	<input type="radio"/>	<input type="radio"/>	<input type="radio"/>
PostScript printer driver			<input type="radio"/>
Font Manager 2000			<input type="radio"/>
SmartNetMonitor for Admin			<input type="radio"/>
SmartNetMonitor for Client	<input type="radio"/>		<input type="radio"/>

^{*1} Available operating systems are as follows: Windows 95/98/Me, Windows 2000, Windows XP/Server 2003, Windows NT 4.0

^{*2} Using custom installation, you can install various software separately.

Reference

When the printer is connected to the computer using USB, see p.80 "Installing the Printer Driver Using USB".

When the printer is connected to the computer using IEEE 1394, see p.83 "Installing the Printer Driver Using IEEE 1394".

Important

- Before starting this installation, close all documents and applications. In a network environment, confirm that users who are logged on are disconnected. Be sure to do this when it will create the least interference with other users.
- After installing a printer driver, you must restart the computer.

Note

- If the "plug and play" function starts, click **[Cancel]** in the **[New Hardware Found]**, **[Device Driver Wizard]** or **[Found New Hardware Wizard]** dialog box, and then insert the CD-ROM. The **[New Hardware Found]**, **[Device Driver Wizard]** or **[Found New Hardware Wizard]** dialog box appears depending on the system version of Windows 95/98/Me, or Windows 2000/Windows XP/Server 2003.

Quick Install

Auto Run will start the installer automatically when you load the CD-ROM in the CD-ROM drive. By selecting Quick Install, you can install the necessary software easily.

TCP/IP requires the following:

- This machine must be connected to the network through the network interface cable.
- This machine must be turned on.
- The TCP/IP protocol must be configured.
- An IP address must be allocated to this machine and to the computer.

Limitation

- If your system is Windows 2000/Windows XP/Server 2003 or Windows NT 4.0, installing a printer driver by Auto Run requires Administrators permission. When you install a printer driver by Auto Run, log on using an account that has Administrators permission.
- When the printer is connected to the computer using USB or IEEE 1394, Quick Install cannot be used. See p.80 "Installing the Printer Driver Using USB" or p.83 "Installing the Printer Driver Using IEEE 1394".

Note

- Auto Run might not automatically work with certain OS settings. In this case, launch "Setup.exe" located on the CD-ROM root directory.

If you want to cancel Auto Run, hold down the **[SHIFT]** key (when your system is Windows 2000/Windows XP/Server 2003, hold down the left **[SHIFT]** key) while inserting the CD-ROM. Keep the **[SHIFT]** key held down until the computer has finished accessing the CD-ROM.

1 Close all applications that are running.

2 Insert the CD-ROM into the CD-ROM drive.

Auto Run will start the installer.

3 Select a language to change the interface language, and then click **[OK]**.

The following languages are available: Cestina (Czech), Dansk (Danish), Deutsch (German), English (English), Espanol (Spanish), Francais (French), Italiano (Italian), Magyar (Hungarian), Nederlands (Dutch), Norsk (Norwegian), Polski (Polish), Portugues (Portuguese), Suomi (Finnish), Svenska (Swedish)

Default interface language is English.

4 Select **[Quick Install]**.

5 The software license agreement appears in the **[License Agreement]** dialog box.

After reading through all of the contents, click **[I accept the agreement]** to agree with the license agreement, and then click **[Next]**.

6 Click to select a model name you want to use when the "Select Printer" dialog box appears.

 **Note**

- For a network connection with TCP/IP, select the printer whose IP address is displayed in **[Connect To]**.
- For parallel connection, select the printer whose printer port is displayed in **[Connect To]**.

7 Click **[Install]**.

8 Follow the instructions on the screen.

 **Note**

- During installation in Windows 2000, the **[Digital Signature Not Found]** dialog box may appear. In this case, click **[Yes]** to continue the installation.
- During installation in Windows XP/Server 2003, the **[Hardware Installation]** dialog box may appear. In this case, click **[Continue Anyway]** to continue the installation.

A message prompting you to restart your computer may appear. To complete the installation, restart your computer.

Installing the PCL 6/5e Printer Driver

Installing the PCL 6/5e Printer Driver

Two kinds of PCL printer drivers, PCL 6 and PCL 5e, are provided with this printer. We recommend PCL 6 as your first choice.

Limitation

- If your system is Windows 2000/Windows XP/Server 2003 or Windows NT 4.0, installing a printer driver by Auto Run requires Administrators permission. When you install a printer driver by Auto Run, log on using an account that has Administrators permission.

Important

- When updating the printer driver by installing the latest version, you should uninstall that of former version if any. See *“Uninstalling the Printer Driver and Software”* in the Printer Reference.

1 Close all applications that are running.

2 Insert the CD-ROM into the CD-ROM drive.

Auto Run will start the installer.

Important

- Never have two versions of the same printer driver installed on your system at the same time. When upgrading to a new version of the printer driver, delete the old version, and then install the new one.

Note

- Auto Run might not work automatically due to certain operating system settings. If this is the case, launch *“Setup.exe”* located in the CD-ROM root directory.

3 Select a language to change the interface language, and then click **[OK]**.

The following languages are available: Cestina (Czech), Dansk (Danish), Deutsch (German), English (English), Espanol (Spanish), Francais (French), Italiano (Italian), Magyar (Hungarian), Nederlands (Dutch), Norsk (Norwegian), Polski (Polish), Portugues (Portuguese), Suomi (Finnish), Svenska (Swedish)

Default interface language is English.

4 Select **[PCL/RPCS Printer Drivers]**.

5 The software license agreement appears in the **[License Agreement]** dialog box.

After reading through all of the contents, click **[I accept the agreement]** to agree with the license agreement, and then click **[Next]**.

6 Select the printer driver you want to install when the "Select Program" dialog box appears.

7 Follow the instructions on the screen.

 **Note**

- During installation in Windows 2000, the **[Digital Signature Not Found]** dialog box may appear. In this case, click **[Yes]** to continue the installation.
- During installation in Windows XP/Server 2003, the **[Software Installation]** dialog box may appear. In this case, click **[Continue Anyway]** to continue the installation.

Setting Up Options

 **Important**

- If the printer is equipped with certain options, you should set up the options with the printer driver.

 **Limitation**

- In Windows 2000/Windows XP/Server 2003, changing the printer settings requires Manage Printers permission. Members of the Administrators and Power Users groups have Manage Printers permission by default. When you set up options, log on using an account that has Manage Printers permission.
- In Windows NT4.0, changing the setting of the printer requires Full Control permission. Members of the Administrators, Server Operators, Print Operators, and Power Users groups have Full Control permission by default. When you set up options, log on using an account that has Full Control permission.

 **Note**

- When setting up options, you should access the Printer Properties dialog box from Windows. You cannot set up options by accessing the Printer Properties dialog box from an application.

1 Click **[Start]** on the taskbar, point to **[Settings]**, and then click **[Printers]**.

The **[Printers]** window appears.

 **Note**

- With Windows XP Professional/Windows Server 2003, open the **[Printers and Faxes]** window from **[Start]** on the taskbar.
- With Windows XP Home Edition, open **[Control panel]** from **[Start]**, click **[Printers and Other Hardware]**, and then click **[Printers and Faxes]** on the screen that appears.

2 Click to select the icon of the printer you want to use.

3 On the **[File]** menu, click **[Properties]**.

The Printer Properties appear.

- 4** Click the **[Accessories]** tab.
- 5** Select options you have installed from the **[Options]** group.
- 6** Click **[OK]**.

Installing the RPCS Printer Driver

Installing the RPCS Printer Driver

Limitation

- If your system is Windows 2000/Windows XP/Server 2003 or Windows NT 4.0, installing a printer driver by Auto Run requires Administrators permission. When you install a printer driver by Auto Run, log on using an account that has Administrators permission.

Important

- When updating the printer driver by installing the latest version, you should uninstall that of former version if any. See “*Uninstalling the Printer Driver and Software*” in the Printer Reference.

1 Close all applications that are running.

2 Insert the CD-ROM into the CD-ROM drive.

Auto Run will start the installer.

Important

- Never have two versions of the same printer driver installed on your system at the same time. When upgrading to a new version of the printer driver, delete the old version, and then install the new one.

Note

- Auto Run might not work automatically due to certain operating system settings. If this is the case, launch “Setup.exe” located in the CD-ROM root directory.

3 Select a language to change the interface language, and then click **[OK]**.

The following languages are available: Cestina (Czech), Dansk (Danish), Deutsch (German), English (English), Espanol (Spanish), Francais (French), Italiano (Italian), Magyar (Hungarian), Nederlands (Dutch), Norsk (Norwegian), Polski (Polish), Portugues (Portuguese), Suomi (Finnish), Svenska (Swedish)

Default interface language is English.

4 Select **[PCL/RPCS Printer Drivers]**.

5 The software license agreement appears in the **[License Agreement]** dialog box.

After reading through all of the contents, click **[I accept the agreement]** to agree with the license agreement, and then click **[Next]**.

6 Select the RPCS printer driver when the "Select Program" dialog box appears.

7 Follow the instructions on the screen.

 **Note**

- During installation in Windows 2000, the **[Digital Signature Not Found]** dialog box may appear. In this case, click **[Yes]** to continue the installation.
- During installation in Windows XP/Server 2003, the **[Software Installation]** dialog box may appear. In this case, click **[Continue Anyway]** to continue the installation.

Setting Up Options

4

 **Important**

- If the printer is equipped with certain options, you should set up the options with the printer driver.

 **Limitation**

- In Windows 2000/Windows XP/Server 2003, changing the printer settings requires Manage Printers permission. Members of the Administrators and Power Users groups have Manage Printers permission by default. When you set up options, log on using an account that has Manage Printers permission.
- In Windows NT4.0, changing the setting of the printer requires Full Control permission. Members of the Administrators, Server Operators, Print Operators, and Power Users groups have Full Control permission by default. When you set up options, log on using an account that has Full Control permission.

 **Note**

- When setting up options, you should access the Printer Properties dialog box from Windows. You cannot set up options by accessing the Printer Properties dialog box from an application.

1 Click **[Start]** on the taskbar, point to **[Settings]**, and then click **[Printers]**.

The **[Printers]** window appears.

 **Note**

- With Windows XP Professional/Windows Server 2003, open the **[Printers and Faxes]** window from **[Start]** on the taskbar.
- With Windows XP Home Edition, open **[Control panel]** from **[Start]**, click **[Printers and Other Hardware]**, and then click **[Printers and Faxes]** on the screen that appears.

2 Click to select the icon of the printer you want to use.

3 On the **[File]** menu, click **[Properties]**.

The Printer Properties appear.

- 4** Click the **[Change Accessories]** tab.
- 5** Select options you have installed from the **[Select printer options]** group.
- 6** Click **[OK]**.

Installing the PostScript Printer Driver

This section describes basic instructions for installing the PostScript printer driver. The actual procedure may differ depending on the operating system. Follow the appropriate procedures below.

Important

- When updating the printer driver by installing the latest version, you should uninstall that of former version if any. See *“Uninstalling the Printer Driver and Software”* in the Printer Reference.

Windows 95/98/Me - Installing the PostScript Printer Driver

4

Installing the printer driver

1 Close all applications that are running.

2 Insert the CD-ROM into the CD-ROM drive.

Auto Run will start the installer.

Important

- Never have two versions of the same printer driver installed on your system at the same time. When upgrading to a new version of the printer driver, delete the old version, and then install the new one.

Note

- Auto Run might not work automatically due to certain operating system settings. If this is the case, launch *“Setup.exe”* located in the CD-ROM root directory.

3 Select a language to change the interface language, and then click [OK].

The following languages are available: Cestina (Czech), Dansk (Danish), Deutsch (German), English (English), Espanol (Spanish), Francais (French), Italiano (Italian), Magyar (Hungarian), Nederlands (Dutch), Norsk (Norwegian), Polski (Polish), Portugues (Portuguese), Suomi (Finnish), Svenska (Swedish)

Default interface language is English.

Note

- The printer driver with the selected language will be installed.
- The printer driver will be installed in English if you select the following languages: Cestina, Magyar, Polski, Portugues and Suomi.

4 Select [PostScript 3 Printer Driver].

[Add Printer Wizard] starts.

- 5** Click **[Next]**.
- 6** Check **[Local Printer]** and then click **[Next]**.
A dialog box for selecting the printer appears.
- 7** Select the printer you want to use, and then click **[Next]**.
- 8** Follow the instructions on the screen.

Setting up options

Important

- If the printer is equipped with certain options, you should set up the options with the printer driver.

- 1** Click **[Start]** on the taskbar, point to **[Settings]**, and then click **[Printers]**.
The **[Printers]** window appears.
- 2** Click to select the icon of the printer you want to use.
- 3** On the **[File]** menu, click **[Properties]**.
The Printer Properties appear.
- 4** Click the **[Accessories]** tab.
- 5** Select options you have installed from the **[Options]** group.
- 6** Click **[OK]**.

Windows 2000/Windows XP/Server 2003 - Installing the PostScript Printer Driver

Installing the printer driver

Limitation

- Installing a printer driver requires Administrators permission. When you install a printer driver, log on using an account that has Administrators permission.

1 Close all applications that are running.

2 Insert the CD-ROM into the CD-ROM drive.

Auto Run will start the installer.

Important

- Never have two versions of the same printer driver installed on your system at the same time. When upgrading to a new version of the printer driver, delete the old version, and then install the new one.

Note

- Auto Run might not work automatically due to certain operating system settings. If this is the case, launch "Setup.exe" located in the CD-ROM root directory.

3 Select a language to change the interface language, and then click [OK].

The following languages are available: Cestina (Czech), Dansk (Danish), Deutsch (German), English (English), Espanol (Spanish), Francais (French), Italiano (Italian), Magyar (Hungarian), Nederlands (Dutch), Norsk (Norwegian), Polski (Polish), Portugues (Portuguese), Suomi (Finnish), Svenska (Swedish)

Default interface language is English.

Note

- The printer driver with the selected language will be installed.
- The printer driver will be installed in English if you select the following languages: Cestina, Magyar, Polski, Portugues and Suomi.

4 Select [PostScript 3 Printer Driver].

[Add Printer Wizard] starts.

5 Click [Next].

6 Check [Local Printer] and then click [Next].

A dialog box for selecting the printer port appears.

7 Select the check box of the port you want to use, and then click **[Next]**.

A dialog box for selecting the printer appears.

8 Select the printer you want to use, and then click **[Next]**.**9** Follow the instructions on the screen. **Note**

- During installation, the **[Digital Signature Not Found]** dialog box may appear. In this case, click **[Yes]** to continue the installation.
- During installation in Windows XP/Server 2003, the **[Hardware Installation]** dialog box may appear. In this case, click **[Continue Anyway]** to continue the installation.

Setting up options

 **Important**

- If the printer is equipped with certain options, you should set up the options with the printer driver.

 **Limitation**

- Changing the printer settings requires Manage Printers permission. Members of the Administrators and Power Users groups have Manage Printers permission by default. When you set up options, log on using an account that has Manage Printers permission.

1 Click **[Start]** on the taskbar, point to **[Settings]**, and then click **[Printers]**.

The **[Printers]** window appears.

 **Note**

- With Windows XP Professional/Windows Server 2003, open the **[Printers and Faxes]** window from **[Start]** on the taskbar.
- With Windows XP Home Edition, open **[Control panel]** from **[Start]**, click **[Printers and Other Hardware]**, and then click **[Printers and Faxes]** on the screen that appears.

2 Click to select the icon of the printer you want to use.**3** On the **[File]** menu, click **[Properties]**.

The Printer Properties appear.

4 Click the **[Device Settings]** tab.**5** Select options you have installed from the **[Installable Options]**.**6** Click **[OK]**.

Windows NT 4.0 - Installing the PostScript Printer Driver

Installing the printer driver

Limitation

- Installing a printer driver requires Administrators permission. When you install a printer driver, log on using an account that has Administrators permission.

Important

- The CD-ROM containing the Windows NT Server operating system version 4.0, or the Windows NT Workstation operating system is required for installing the printer driver.
- We recommend that you upgrade the Windows NT 4.0 operating system to Service Pack 4 or later before installing the printer driver. Contact your Windows retailer for more information about the latest version available.

1 Close all applications that are running.

2 Insert the CD-ROM into the CD-ROM drive.

Auto Run will start the installer.

Important

- Never have two versions of the same printer driver installed on your system at the same time. When upgrading to a new version of the printer driver, delete the old version, and then install the new one.

Note

- Auto Run might not work automatically due to certain operating system settings. If this is the case, launch "Setup.exe" located in the CD-ROM root directory.

3 Select a language to change the interface language, and then click [OK].

The following languages are available: Cestina (Czech), Dansk (Danish), Deutsch (German), English (English), Espanol (Spanish), Francais (French), Italiano (Italian), Magyar (Hungarian), Nederlands (Dutch), Norsk (Norwegian), Polski (Polish), Portugues (Portuguese), Suomi (Finnish), Svenska (Swedish)

Default interface language is English.

Note

- The printer driver with the selected language will be installed.
- The printer driver will be installed in English if you select the following languages: Cestina, Magyar, Polski, Portugues and Suomi.

- 4** Select **[PostScript 3 Printer Driver]**.
[Add Printer Wizard] starts.
- 5** Click **[Next]**.
- 6** After confirming that the **[My Computer]** option is selected, click **[Next]**.
A dialog box for selecting the printer port appears.
- 7** Select the check box of the port you want to use, and then click **[Next]**.
A dialog box for selecting the printer appears.
- 8** Select the printer you want to use, and then click **[Next]**.
- 9** Follow the instructions on the screen.

Setting up options

Limitation

- Changing the printer settings requires Manage Printers permission. Members of the Administrators and Power Users groups have Manage Printers permission by default. When you set up options, log on using an account that has Manage Printers permission.

Important

- If the printer is equipped with certain options, you should set up the options with the printer driver.

- 1** Click **[Start]** on the taskbar, point to **[Settings]**, and then click **[Printers]**.
The **[Printers]** window appears.
- 2** Click to select the icon of the printer you want to use.
- 3** On the **[File]** menu, click **[Properties]**.
The Printer Properties appear.
- 4** Click the **[Device Settings]** tab.
- 5** Select options you have installed from the **[Installable Options]** group.
- 6** Click **[OK]**.

 **Bidirectional transmission**

When bidirectional transmission is enabled, information about the paper size and feed direction settings is automatically sent to the machine by a computer. You can also check the machine's status from your computer.

- Bidirectional transmissions are supported by Windows 95/98/Me, Windows 2000/Windows XP/Server 2003 and Windows NT 4.0.
- When bidirectional transmission is running, the machine status and information are obtained by opening the printer driver screen.

To support bidirectional transmission, the following conditions are required:

◆ When connecting with a parallel cable

- The computer must support bidirectional transmission.
- The printer must be set to bidirectional transmission.
- The Interface cable must support bidirectional transmission.
- The machine must be connected to the computer using the standard parallel cable and parallel connector.
- Under Windows 95/98/Me, **[Enable bidirectional support for this printer]** must be selected in **[Spool Settings...]** on the **[Details]** tab with RPCS printer driver.
- Under Windows 2000/Windows XP/Server 2003 and Windows NT 4.0, **[Enable bidirectional support]** must be selected and **[Enable printer pooling]** must not be selected on the **[port]** tab with RPCS printer driver.

◆ When connecting with the network

- The printer must be set to bidirectional transmission.
- SmartNetMonitor for Client included on the CD-ROM must be installed, and the TCP/IP protocol must be used.
- Under Windows 95/98/Me, **[Enable bidirectional support for this printer]** must be selected in **[Spool Settings...]** on the **[Details]** tab with RPCS printer driver.
- Under Windows 2000/Windows XP/Server 2003 and Windows NT 4.0, **[Enable bidirectional support]** must be selected and **[Enable printer pooling]** must not be selected on the **[port]** tab with RPCS printer driver.

◆ When connecting with IEEE 1394

- The printer must be connected to the IEEE 1394 connector of a computer using the IEEE 1394 interface cable.
- **[Activate]** is selected in the SCSI print of IEEE 1394 and **[Activate]** is selected in the Bidi-SCSI print.
- Under Windows 2000/Windows XP/Server 2003 and Windows NT 4.0, **[Enable bidirectional support]** must be selected and **[Enable printer pooling]** must not be selected on the **[port]** tab with RPCS printer driver.

❖ When connecting with USB

The printer must be connected to the USB connector of a computer using the USB interface cable.

💡 Cautions when connecting the USB interface cable and the IEEE 1394 interface cable

🔔 Limitation

- Do not unplug the cable while printing. Do not turn off the printer power while printing or during bidirectional transmission.

Mac OS - Installing the PostScript 3 Printer Driver

📁 Preparation

If the AdobePS installation starts under Mac OS X, the desktop automatically changes to the Classic environment. If you want to set a printer with Mac OS X, see p.78 “Mac OS X - Installing the PostScript 3 Printer Driver”.

This section describes how to configure Mac OS to use EtherTalk and USB. The following procedure describes how to configure Mac OS 9.1. If you are not using Mac OS 9.1, see the manual that comes with your version of the Mac OS for more information.

🔔 Limitation

- For use with Mac OS 8.6 or later. (Mac OS X Classic environment is supported.)
- For use with a Macintosh, Power PC is required.

📝 Note

- The PostScript 3 printer driver is stored in the following folder on the CD-ROM:

Mac OS 8 and 9:PS Driver:(language):Disk1

- 1** Insert the CD-ROM into the CD-ROM drive.
- 2** Double-click the CD-ROM icon.
- 3** Double-click the [Mac OS 8 and 9] folder.
- 4** Double-click the [PS Driver] folder.
- 5** Double-click the folder of the language you are using.
- 6** Open [DISK1], and then double-click the installer icon.

- 7** Follow the instructions on the screen.
- 8** Double-click the CD-ROM icon.
- 9** Double-click the [Mac OS 8 and 9] folder.
- 10** Double-click the [Printer Descriptions] folder.
- 11** Double-click the folder of the language you are using.
- 12** Open [Disk1].
- 13** Drag the PPD file and the Plugin file into [Printer Descriptions] in [Extensions] which is in [System Folder].
- 14** Restart the Macintosh.

Setting up the PPD file

Preparation

Make sure that the machine is connected to an AppleTalk network before performing the following procedure.

- 1** On the [Apple] menu, select [Chooser].
- 2** Click the [Adobe PS] icon.
- 3** In the [Select a PostScript Printer:] list, click the name of the machine you want to use.
- 4** Click [Setup].
- 5** Click the printer description file you want to use, and then click [Select].

The PPD file is set up, and the [Adobe PS] icon appears at the left of the machine name in the list. Next, follow the procedure on p.76 "Setting up options" to make the option settings, or close the [Chooser] dialog box.

Setting up options

- 1** On the [Apple] menu, select [Chooser].
- 2** Click the [Adobe PS] icon.
- 3** In the [Select the PostScript Printer:] list, click the name of the machine you want to use, and then click [Setup].
- 4** Click [Configure].

A list of options appears.

5 Select the option you want to set up and select the appropriate setting for it. **Note**

- If the option you want to set up is not displayed, the PPD file might not be set up correctly. Check the name of the PPD file shown in the dialog box.

6 Click [OK].

The list of options closes.

7 Click [OK].

The [Chooser] dialog box appears.

8 Close the [Chooser] dialog box. **Reference**

For information about installing the Printer Utility for Mac, see the PostScript 3 Operating Instructions Supplement.

Installing the Adobe Type Manager

 **Note**

- Close all applications that are running before the installation. Install ATM after restarting the computer.

1 Start the Macintosh.**2** Insert the CD-ROM into the CD-ROM drive.**3** Double-click the CD-ROM icon.**4** Double-click the [Mac OS 8 and 9] folder.**5** Double-click the [ATM] folder.**6** Double-click the [ATM 4.6.2 installer] icon.**7** Follow the instructions on the screen.**8** When the procedure is complete, restart the computer. ATM will be completely installed only after restarting.**9** On the [Apple] menu, click [Control Panel], and then click [-ATM].**10** Open the ATM control panel. **Note**

- For more information about installation, see the user's guide in the ATM folder.

Installing screen fonts

The screen fonts described below can be found on the CD-ROM, in the folder named **[Fonts]**.

1 Start the Macintosh.

2 Insert the CD-ROM into the CD-ROM drive.

The CD-ROM icon appears.

3 Double-click the CD-ROM icon.

The contents of the CD-ROM appear.

4 Double-click the **[Mac OS 8 and 9]** folder.

5 Double-click the **[Fonts]** folder.

6 Double-click the **[Screen font]** folder.

7 Double-click the **[TrueType]** or **[Type1]** folder.

Select the font enter you want to use.

8 Copy the fonts you want to install into **[Fonts]** in the **[System Folder]**.

A Confirmation dialog box appears.

9 Click **[OK]**.

The fonts are installed.

10 Restart the Macintosh.

Mac OS X - Installing the PostScript 3 Printer Driver

This section describes how to configure a Mac OS X to use Ether Talk. The following procedure describes how to configure Mac OS X 10.1. If you are not using Mac OS X 10.1, see the manual that comes with your version of the Mac OS X for more information.

 **Limitation**

- For use with Mac OS X 10.1 or later.
- For use with a Macintosh, PowerPC G3 or later is required.

 **Note**

- The PPD file is stored in the following folder on the CD-ROM:

Mac OS X:PPD Installer

Installing the PPD File

It is necessary to install a PPD file to print from a Macintosh.

Preparation

You need an administrator name and a password (phrase). For more information, consult your administrator.

- 1** Insert the CD-ROM into the CD-ROM drive.
- 2** Double-click the CD-ROM icon.
- 3** Double-click the [Mac OS X] folder.
- 4** Double-click the installer icon.
- 5** Follow the instructions on the screen.

Setting Up the PPD File

1 Run Print Center.

2 Click [Add Printer].

Click [AppleTalk] in the first pop-up menu.

If the zone has been set, select the zone in the second pop-up menu.

3 Select the PPD file of the model you are using on the [Printer Model:] pop-up menu, and then click [Add].

Setting Up Options

Limitation

- You can make all the settings of printer features, even if the necessary option is not installed, due to the limitation of Mac OS X native mode. Confirm which option is installed to the machine before you print.

Installing the Printer Driver Using USB

This section describes basic instructions for installing the printer drivers using USB. The printer drivers can be installed from the provided CD-ROM.

Important

- Be sure that all other applications are closed and that the computer is not currently making prints before installation.

Windows 98SE/Me-Installing the Printer Driver Using USB

4

The procedure below takes Windows 98SE as an example. The procedure for Windows Me may be slightly different.

When the USB cable is used for the first time, the "plug and play" function starts and **[New Hardware Found]**, **[Device Driver Wizard]** or **[Found New Hardware Wizard]** dialog box appears depending on the system used.

If the printer driver is already installed, the "plug and play" is displayed, and the printer with its port directed to the USB cable is added to the "Printers" folder.

1 Click **[Next>]**.

2 Select **[Search for the best driver for your device. {Recommended}.]**, and then click **[Next>]**.

3 Check **[Specify a location:]**, and then click **[Browse...]**.

The **[Browse for Folder]** dialog box appears.

4 Insert the CD-ROM provided into the CD-ROM drive.

When Auto Run starts, click **[Exit]**.

Note

- If you want to inactivate Auto Run, press **[Shift]** when inserting the CD-ROM into the drive and keep it pressed until the computer completes transmission to the drive.

5 Select the drive where the printer driver is located according to the operating system used, and then click **[Next>]**.

If the CD-ROM drive is D, the folder will be "D:\Drivers\USB-PRINT\WIN98ME".

6 Confirm the printer driver location, and then click **[Next>]**.

"USB Printing Support" will be installed.

7 Click **[Finish]**.

8 Follow the "plug and play" on the screen to install the printer drivers.

When the installation is complete, the printer with its port directed to "USB00n" appears on the **[Printers]** folder. ("n" is the number of printers connected.")

Windows 2000/Windows XP/Server 2003-Installing the Printer Driver Using USB

Limitation

- Installing a printer driver requires the Administrators permission. When you install a printer driver, log on using an account that has the Administrators permission.

When the USB cable is used for the first time, the **[Found New Hardware Wizard]** dialog box appears, and Windows 2000/Windows XP/Server 2003's **[USB Printing Support]** will be installed automatically.

If the printer driver is already installed, the "plug and play" is displayed, and the printer with its port directed to the USB cable is added to the "Printers"^{*1} folder.

With Windows XP/Server 2003, even if the printer driver has already been installed, **[Found New Hardware Wizard]** may start when connecting the printer and the computer with the USB cable for the first time. In this case, install the printer driver by following the procedure below.

1 Install the printer driver by referring to the instructions for installing the printer driver with Parallel/Ethernet connection.

When installation is complete, the printer with its port directed to "USB00n" appears on the **[Printers]**^{*1} folder. ("n" is the number of printers connected.)

^{*1} With Windows XP/Server 2003, the folder is **[Printers and Faxes]**.

Mac OS-Creating a Desktop Printer icon

To use a printer connected by USB, create a Desktop Printer icon.

1 Install the printer driver. For more information about how to install the printer driver, see p.68 "Installing the PostScript Printer Driver".

2 Double-click **[Desktop Printer Utility]** in the **[AdobePS Components]** folder.

3 Select **[AdobePS]** in **[With:]** and **[Printer (USB)]** in **[Create Desktop]**, and then click **[OK]**.

4 Click **[Change]** in **[USB Printer Selection]**.

5 Select the model you are using in **[Select a USB Printer:]**, and then click **[OK]**.

6 Click **[Auto Setup]** in **[PostScript™ Printer Description (PPD) File]**.

7 Click **[Create]**.

8 Enter the printer name, and then click **[Save]**.

The printer icon appears on the desktop.

9 Exit the **Desktop Printer Utility**.

Installing the Printer Driver Using IEEE 1394

This section gives basic instructions for installing the printer drivers using IEEE 1394. The printer drivers can be installed from the CD-ROM provided.

Important

- Be sure that all other applications are closed and that the computer is not printing before installation.

Printing with SCSI Print

Printing using a SCSI print device with the optional 1394 Interface Unit is possible under Windows 2000 and Windows XP/Server 2003.

Important

- Do not connect new IEEE 1394 or USB devices to the printer or turn on the printer while installing the printer driver.
- Before uninstalling the printer driver, be sure to disconnect the 1394 interface cable from the computer.
- "SCSI print" must be set active from the control panel. For more information, see p.54 "IEEE 1394 Configuration".

Note

- This machine cannot receive print data from more than one computer at the same time. If you send data from your computer when data is being received from another computer, a message may appear on the computer display.

Installing the Printer Driver

Note

- If [**Found New Hardware Wizard**] appears every time the computer is started or the cable is connected with Windows 2000/Windows XP/Server 2003, inactivate the device. See p.86 "Inactivating the Device". If you want to install another printer driver after setting the "1394_00n" port, select the "1394_00n" port by following the procedures of installing a printer driver.
- When the printer connected via the 1394 Interface Unit is installed properly, the appearance of the icon in the printer folder changes according to whether the cable is plugged in or not.

Windows 2000

- 1** Connect the printer and the computer using the IEEE 1394 interface cable.
- 2** In the [**Found New Hardware Wizard**] dialog box, and then click [**Next>**].

3 When the [This wizard will complete the installation for this Device: Unknown] message appears, select [Optional search locations:], and then click [Next>].

4 When the [Locate Driver Files] message appears, select the [Optional search locations.] check box, and then select [Specify a location], and then click [Next>].

5 Hold down the left [SHIFT] key and insert the CD-ROM into the CD-ROM drive.

Keep the left [SHIFT] key held down until the computer has finished accessing the CD-ROM.

If the Auto Run program starts, click [Cancel], and then [Exit].

6 Click [Browse].

7 Select the printer driver that you want to use. The following are locations where printer drivers are stored:

- RPCS
 \DRIVERS\RPCS\WIN2K_XP\ (Language)\DISK1
- PCL 6
 \DRIVERS\PCL6\WIN2K_XP\ (Language)\DISK1
- PCL 5e
 \DRIVERS\PCL5e\WIN2K_XP\ (Language)\DISK1
- PostScript 3
 \DRIVERS\PS3\WIN2K_XP\ (Language)\DISK1

8 Click [Open].

9 Click [OK].

A printer model selection dialog box appears.

10 Follow the instructions on the screen.

 **Note**

- During installation, the [Digital Signature Not Found] dialog box may appear. In this case, click [Yes] to continue the installation.
- If the printer driver is already installed, the printer icon is automatically added to the [Printer] folder. In such a case, installation of the printer driver is not necessary.
- When the installation is complete, the printer with its port directed to "1394_00n" appears on the [Printers] folder. ("n" is the number of printers connected.)

Windows XP/Server 2003

- 1** Connect the printer and the computer using the IEEE 1394 interface cable.
- 2** In the **[Found New Hardware Wizard]** dialog box, confirm that **[This wizard helps you install software for: (printer name)]** is displayed, and select **[Install from a list on specific location (Advanced)]**, and then click **[Next>]**.
- 3** When the **[Please choose your search and installation option.]** messages appears, select the **[Search for the best driver in these locations.]** check box, and then select the **[Include this location in the search:]** check box, and then select the **[Include this location in the search:]** check box.
- 4** Install the printer driver following the same procedures as steps **5-10** in Windows 2000.

 **Note**

- During installation in Windows XP/Server 2003, the **[Hardware Installation]** dialog box may appear. In this case, click **[Continue Anyway]** to continue the installation.
- When the installation is complete, the printer with its port directed to "1394_00n" appears on the **[Printers and Faxes]** folder. ("n" is the number of printers connected.)
- If the printer driver is already installed, the printer icon is automatically added to the **[Printer]** folder. In this case, installation of the printer driver is not necessary.
- Even if the printer driver has already been installed, **[Found New Hardware Wizard]** may start when connecting the printer and the computer with the IEEE 1394 interface cable for the first time. In this case, install the printer driver by following the procedure.

Printing with IP over 1394

You can print by setting the IP address for this machine and the computer on which Windows XP/Server 2003 is installed.

Preparation

"IP over 1394" must be set on the control panel and an IP address for the IEEE 1394 must be specified.

For more information about how to make printer settings, see p.54 "IEEE 1394 Configuration".

Limitation

- When using the IEEE 1394 (IP over 1394) interface in a network, the Ethernet interface cannot be used in the same network.

Note

- The maximum number of simultaneous print requests when connecting with IP over 1394 includes the print requests from the Ethernet interface. For more information, see the Network Printing Guide.

Installing the Printer Driver

To Print using Standard TCP/IP port. For more information about Standard TCP/IP port settings, see Network Printing Guide.

Inactivating the Device

- ◆ When [Add New Hardware Wizard] starts every time you restart the computer with an operating system, which does not support SCSI print or plug in or out the cable, inactivate the device by following procedures.

- Windows Me
 - ① In the [Add New Hardware Wizard] dialog box, confirm that [Windows has found the following new Hardware: IEEE SBP-2 Device] is displayed, and select [Recommended search for a better driver [Recommended]], and then click [Next>].
 - ② When the [Windows was unable to locate the software for this device.] message appears, click [Finish].

❖ If you do not want to install the printer when [Found New Hardware Wizard] starts with an operating system, which supports SCSI print, inactivate the device by following the procedures.

- Windows XP/Server 2003

- ① In the [Found New Hardware Wizard] dialog box, confirm that [This wizard helps you install software for: Unknown] is displayed, and select [Install from a list on specific location (Advanced)], and then click [Next>].
- ② When the [Please choose your search and installation option.] message appears, remove all the selections from [Search for the best driver in these locations.], and then click [Next>].
- ③ When the [The wizard could not find the software on your computer for..] message appears, click [OK].
- ④ When the [Cannot Install this Hardware] message appears, select the [Don't prompt again to install the software] check box, and then click [Finish].

- Windows 2000

- ① In [Found New Hardware Wizard] dialog box, and then click [Next>].
- ② When the [This wizard will complete the installation for this Device: Unknown] message appears, and select [Search for a suitable driver for my device [recommended]], and then click [Next>].
- ③ When the [Locate Driver Files] message appears, remove all the selections from [Optional search locations.], and then click [Next>].
- ④ When the [Driver Files Search Results] message appears, select the [Disable the device. The Add/Remove Hardware Wizard in the control Panel can be able to complete the driver installations.] check box, and then click [Finish].

❖ When [Found New Hardware Wizard] appears every time you restart the computer with an operating system which does not support IP over 1394, plug in or take out the cable, inactivate the device with the following procedure.

- Windows 2000

- ① In [Found New Hardware Wizard] dialog box, and then click [Next>].
- ② When the [This wizard will complete the installation for this Device:] message appears and "IP over 1394" appears select [Search for a suitable driver for my device [recommended]], and then click [Next>].
- ③ When the [Locate Driver Files] message appears, remove all the selections from [Optional search locations.], and then click [Next>].
- ④ When the [Driver Files Search Results] message appears, select the [Disable the device. The Add/Remove Hardware Wizard in the control Panel can be able to complete the driver installations.] check box, and then click [Finish].



Installing the SmartNetMonitor for Client/Admin

📌 Limitation

- ❑ If your system is Windows 2000/Windows XP/Server 2003 or Windows NT 4.0, installing software by Auto Run requires Administrators permission. When you install a printer driver by Auto Run, log on using an account that has Administrators permission.

1 Close all applications that are running.

2 Insert the CD-ROM into the CD-ROM drive.

Auto Run will start the installer.

3 Select a language to change the interface language, and then click **[OK]**.

The following languages are available: Cestina (Czech), Dansk (Danish), Deutsch (German), English (English), Espanol (Spanish), Francais (French), Italiano (Italian), Magyar (Hungarian), Nederlands (Dutch), Norsk (Norwegian), Polski (Polish), Portugues (Portuguese), Suomi (Finnish), Svenska (Swedish)

Default interface language is English.

4 Select **[SmartNetMonitor for Client / Admin]**.

5 The software license agreement appears in the **[License Agreement]** dialog box.

After reading through all of the contents, click **[I accept the agreement]** to agree with the license agreement, and then click **[Next]**.

6 Select the program you want to install when the "Select Program" dialog box appears.

7 Follow the instructions on the screen.

Installing the Font Manager 2000

⚠ Limitation

- If your system is Windows 2000/Windows XP/Server 2003 or Windows NT 4.0, installing software by Auto Run requires Administrators permission. When you install a printer driver by Auto Run, log on using an account that has Administrators permission.

1 Close all applications that are running.

2 Insert the CD-ROM into the CD-ROM drive.

Auto Run will start the installer.

3 Select [Font Manager 2000].

4 Follow the instructions on the screen.

Using Adobe PageMaker Version 6.0, 6.5, or 7.0

If you use this printer under Windows 95/98/Me, Windows 2000, Windows XP/Server 2003, or Windows NT 4.0 with Adobe PageMaker, you need to copy the PPD file to the PageMaker folder.

The PPD file is the file with extension “.ppd” in the folder “DRIVERS\PS\WIN9X_ME\ (Language)\DISK1\” on the CD-ROM.

The “WIN9X_ME” folder, inside the “PS” folder is for Windows 95/98/Me. Use the folder at a level appropriate for your operating system.

The third folder, “(Language)” may be substituted for an appropriate language name.

Copy the file with the extension “.ppd” to the PageMaker folder.

- **For PageMaker 6.0 default installation**

The directory is “C:\PM6\RSRC\PPD4”.

- **For PageMaker 6.5 default installation**

The directory is “C:\PM65\RSRC\USENGLISH\PPD4”.

The “USENGLISH” may vary depending on your language selection.

- **For PageMaker 7.0 default installation**

The directory is “C:\PM7\RSRC\USENGLISH\PPD4”.

The “USENGLISH” may vary depending on your language selection.

Note

- If the driver is not set correctly after copying the “.ppd” file, printing may not be performed properly.
- When using PageMaker, the optional features that can be selected by the printer driver will not be active. The following procedure describes how to activate the optional printer features.
 - ① On the **[File]** menu, click **[Print]**.
The **[Print Document]** dialog box appears.
 - ② Make the necessary settings in the **[Features]** box.

INDEX

1394 Interface Unit Type 4510, 21, 22, 33
802.11b Interface Unit Type A, 21, 22, 37

A

AD450 (Duplex Unit), 20, 46

B

Bluetooth Interface Unit Type 2045, 21, 22, 40
Bypass Tray, 13
Bypass Tray Extension, 13

C

Caution, 2
Controller Board, 14
Control Panel, 13, 16

D

Data In indicator, 16

E

Enter key, 17
Envelope Feeder Type 400, 20, 25
Error indicator, 16
Escape key, 17

F

Font Manager 2000, 11, 89
Form Feed key, 16
Friction pad, 14
Front Cover, 15
Front Cover Release Buttons, 14
Fusing Unit, 15
Fusing Unit Lock Levers, 15

G

Gateway Address, 58
Guide Board, 15

H

Hard Disk Drive Type 2600, 21, 22, 44

J

Job Reset key, 16

M

Memory Unit Type C (SDRAM Module),
21, 22, 26
Menu key, 16

N

Network Interface Board Type 2610, 21, 29
Network Printing Guide, 6

O

On Line key, 16
Options, 19
options, available, 20
options, setting up
 Windows 2000/Windows XP/Server 2003, 71
 Windows 95/98/Me, 69
 Windows NT 4.0, 73
Output Tray, 13

P

PageMaker, 90
Panel display, 16
Paper Feed Unit Type 400, 23
Paper Feed Unit Type 400 (Tray 2 or Tray 3), 20
Paper Size Dial, 13
Paper Tray, 14
PCL 5e, 9
 *Windows 2000/Windows XP/Server
 2003, installing*, 62
 Windows 95/98/Me, installing, 62
 Windows NT 4.0, installing, 62
PCL 6, 9
 *Windows 2000/Windows XP/Server
 2003, installing*, 62
 Windows 95/98/Me, installing, 62
 Windows NT 4.0, installing, 62
PostScript 3, 10
 Macintosh, Install, 75, 78
 *Windows 2000/Windows XP/Server
 2003, installing*, 70
 Windows 95/98/Me, installing, 68
 Windows NT 4.0, installing, 72

Power Cord, 14
Power indicator, 16
Power Switch, 14
printer driver, 9
Printer Reference, 6

Q

Quick Install, 60
Quick Installation Guide, 6

PCL 6, installing, 62
PostScript 3, installing, 72
RPCS, installing, 65
setting up options, 73

R

Rear Cover, 14
Registration Roller, 15
RPCS
 Windows 2000/Windows XP/Server
 2003, installing, 65
 Windows 95/98/Me, installing, 65
 Windows NT 4.0, installing, 65

S

Setup Guide, 6
SmartNetMonitor for Admin, 11, 88
SmartNetMonitor for Client, 11, 88
Standard Tray, 14
Subnet Mask, 58

T

Toner Cartridge, 15
Transfer Roller, 15
Transfer Roller Cover, 15

U

Upper Cover, 13

V

Ventilator, 14

W

Warning, 2
Windows 2000/Windows XP/Server 2003
 PCL 5e, installing, 62
 PCL 6, installing, 62
 PostScript 3, installing, 70
 RPCS, installing, 65
 setting up options, 71
Windows 95/98/Me
 PCL 5e, installing, 62
 PCL 6, installing, 62
 PostScript 3, installing, 68
 RPCS, installing, 65
 setting up options, 69
Windows NT 4.0
 PCL 5e, installing, 62

MEMO

MEMO



Declaration of Conformity

“The Product complies with the requirements of the EMC Directive 89/336/EEC and its amending directives and the Low Voltage Directive 73/23/EEC and its amending directives.”

Warning

Changes or modifications not expressly approved by the party responsible for compliance could void the user's authority to operate the equipment.



Notice to Users in EEA Countries

802.11b Interface Unit TypeA(R-WL11):

This product complies with the essential requirements and provisions of Directive 1999/5/EC of the European Parliament and of the Council of 9 March 1999 on radio equipment and telecommunications terminal equipment and the mutual recognition of their conformity.

This product is only for use in EEA or other authorized countries. Outdoor use of this product in Belgium, France, Germany, Italy, or the Netherlands is prohibited.

The CE Declaration of Conformity is available on the Internet at URL:

http://www.ricoh.co.jp/fax/ce_doc/.

In accordance with IEC 60417, this machine uses the following symbols for the main power switch:

I means **POWER ON**.

O means **POWER OFF**.



RICOH COMPANY, LTD.

15-5, Minami Aoyama 1-chome,
Minato-ku, Tokyo 107-8544, Japan
Phone: +81-3-3479-3111



Aficio™ AP400/AP400N

Setup Guide

Overseas Affiliates

U.S.A.

RICOH CORPORATION
5 Dedrick Place
West Caldwell, New Jersey 07006
Phone: +1-973-882-2000

The Netherlands

RICOH EUROPE B.V.
Groenelaan 3, 1186 AA, Amstelveen
Phone: +31-(0)20-5474111

United Kingdom

RICOH UK LTD.
Ricoh House,
1 Plane Tree Crescent, Feltham,
Middlesex, TW13 7HG
Phone: +44-(0)20-8261-4000

Germany

RICOH DEUTSCHLAND GmbH
Mergenthalerallee 38-40,
65760 Eschborn
Phone: +49-(0)6196-9060

France

RICOH FRANCE S.A.
383, Avenue du Général de Gaulle
BP 307-92143 Clamart Cedex
Phone: +33-(0)-821-01-74-26

Spain

RICOH ESPAÑA S.A.
Avda. Litoral Mar, 12-14,
Blue Building, Marina Village,
08005 Barcelona
Phone: +34-(0)93-295-7600

Italy

RICOH ITALIA SpA
Via della Metallurgia 12,
37139 Verona
Phone: +39-045-8181500

China

RICOH CHINA CO.,LTD.
29/F., Lippo Plaza, No.222
Huai Hai Zhong Road,
Lu Wan District,
Shanghai P.C.:200021
Phone: +86-21-5396-6888

Singapore

RICOH ASIA PACIFIC PTE.LTD.
260 Orchard Road,
#15-01/02 The Heeren,
Singapore 238855
Phone: +65-6830-5888

Model number: Aficio AP400, Aficio AP400N

Printed in The Netherlands

GB  G095-8616